

**PRESSURE FILTER**  
**Series LF 1211-10011 DN 50-250 PN 10**

Sheet No.  
**1127 B1**

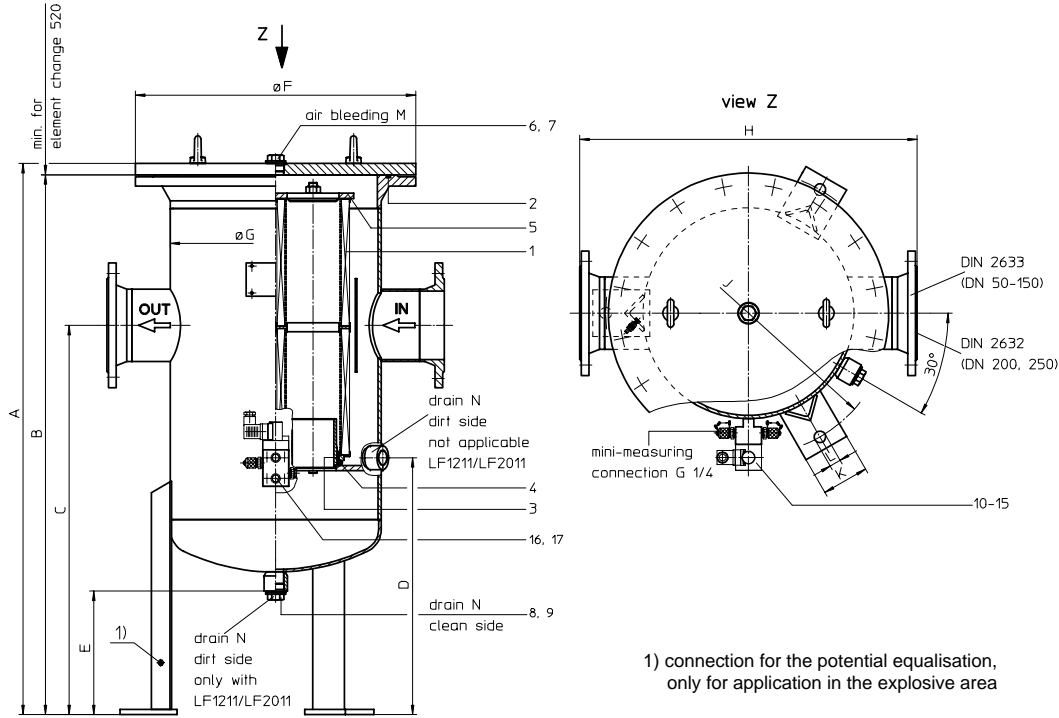

1) connection for the potential equalisation, only for application in the explosive area

**3. Dimensions:**

type	connection DN	A	B	C	D	E	F	G	H	J	K	L	M	N	weight kg	volume tank
LF 1211	50	1052	1028	400	-	188	340	219	412	330	70	18	G 1/2	G1	60	26,0 l
	65	1071	1047													27,0 l
	80	1052	1028													26,0 l
	100	1128	1104													29,0 l
LF 2011	65	1093	1067	425	-	186	395	273	494	380	70	18	G1	G1	110	43,5 l
	80	1112	1086													44,5 l
	100	1100	1074													43,5 l
	125	1188	1162													48,0 l
LF 2411	65	1016	990	700	445	183	445	324	600	450	70	18	G1	G1	130	55,0 l
	80															
	100															
	125															
LF 3611	80	1066	1040	750	495	238	565	406	650	550	90	22	G1	G1	260	90,0 l
	100															
	125															
	150															
LF 4811 LF 6011	100	1108	1080	800	535	232	670	508	800	650	90	22	G1	G1	310	145,0 l
	125															
	150															
	200															
LF 10011	125	1148	1110	800	570	288	895	711	1000	900	120	22	G1 1/2	G1 1/2	560	283,0 l
	150															
	200															
	250															

**1. Type index:**

**1.1. Complete filter: (ordering example)**

**LF. 2011. 10VG. 10. E. P. -. FD1. 9. -. AE**

1	2	3	4	5	6	7	8	9	10	11
---	---	---	---	---	---	---	---	---	----	----

- 1 series:  
LF = in-line filter
- 2 nominal size: 1211, 2011, 2411, 3611, 4811, 6011, 10011
- 3 filter material and filter fineness:  
80 G = 80 µm, 40 G = 40 µm, 25 G = 25 µm stainless steel wire mesh,  
25 VG = 20 µm<sub>(c)</sub>, 16 VG = 15 µm<sub>(c)</sub>, 10 VG = 10 µm<sub>(c)</sub>, 6 VG = 7 µm<sub>(c)</sub>, 3 VG = 5 µm<sub>(c)</sub> Interpor fleece (glass fibre)
- 4 resistance of pressure difference for filter element:  
10 = Δp 10 bar
- 5 filter element design:  
E = without by-pass valve; S = with by-pass valve Δp 2,0 bar
- 6 sealing material:  
P = Nitrile (NBR); V = Viton (FPM)
- 7 filter element specification: (see catalog)  
- = standard  
VA = stainless steel  
IS06 = see sheet-no. 31601
- 8 connection:  
FD11 = flange DIN 2632, design C DIN 2526; FD12 = flange DIN 2632, design E DIN 2526 (DN 200, 250)  
FD1 = flange DIN 2633, design C DIN 2526; FD2 = flange DIN 2633, design E DIN 2526 (DN 50-150)
- 9 connection size:

DN	filter nominal size						
8 = 50	1211						
9 = 65	1211	2011	2411				
A = 80	1211	2011	2411	3611			
B = 100	1211	2011	2411	3611	4811	6011	
C = 125		2011	2411	3611	4811	6011	10011
D = 150				3611	4811	6011	10011
E = 200					4811	6011	10011
F = 250							10011

- 10 filter housing specification: (see catalog)  
- = standard  
IS06 = see sheet-no. 31605
- 11 clogging indicator or clogging sensor:  
- = without  
AE = visual-electrical, see sheet-no.1609  
OP = visual, see sheet-no.1628; VS1 = electrical, see sheet-no.1607  
OE = visual-electrical, see sheet-no. 1628 VS2 = electrical, see sheet-no.1608

**1.2. Filter element: (ordering example)**

**01E. 2001. 10VG. 10. E. P. -**

1	2	3	4	5	6	7
---	---	---	---	---	---	---

- 1 series:  
01E. = filter element according to INTERNORMEN factory specification
- 2 nominal size: 1201, 2001
- 3 - 7 see type index-complete filter

**2. Accessories:**

- measure-and bleeder -connections, see sheet-no. 1650
- evacuation- and bleeder-connections, see sheet-no. 1651
- counter flanges, see sheet-no. 1653
- lifting mechanism, see sheet-no. 1661

Changes of measures and design are subject to alteration!



## 4. Spare parts:

### 4.1. Depending on different series:

item	designation	qty.	dimension and article-no. LF 1211	dimension and article-no. LF 2011	qty.	dimension and article-no. LF 2411	qty.	dimension and article-no. LF 3611	dimension and article-no. LF 4811	qty.	dimension and article-no. LF 6011	dimension and article-no. LF 10011	qty.	
1	filter element	1	01E.1201	01E.2001	2	01E.1201	3	01E.1201	4	01E.1201	3	01E.2001	5	01E.2001
2	O-ring	1	225 x 5	275 x 5	1	330 x 5	1	429 x 6	516 x 6	1	516 x 6	722 x 8	1	308145 (NBR)
			308652 (NBR)	307414 (NBR)		303080 (NBR)		308659 (NBR)	301962 (NBR)		308145 (NBR)	311805 (FPM)		
3	O-ring	1	93 x 5	135 x 5	2	93 x 5	3	93 x 5	135 x 5	4	135 x 5	135 x 5	5	306016 (NBR)
			307588 (NBR)	306016 (NBR)		307588 (NBR)		307588 (NBR)	306016 (NBR)		307045 (FPM)	306016 (NBR)		
4	O-ring	1	85 x 10	125 x 10	2	85 x 10	3	85 x 10	125 x 10	4	125 x 10	125 x 10	5	304388 (NBR)
			304386 (NBR)	304388 (NBR)		304386 (NBR)		307589 (FPM)	307045 (FPM)		304388 (NBR)			
5	spring	1	304414		-	-	-	-	-	-	-	-	-	-
	pressure plate	-	-		1	309851	1	313116	1	314718	1	313335	1	313062
6	screw plug	1	G ½	G 1	1	G1		G1		1	G 1 ½		1	318556
			309730	309732		309732		318556						
7	gasket	1	A 22 x 27	A 33 x 39	1	A 33 x 39		A 33 x 39		1	A 48 x 55		1	309764
			305564	308257		308257		309764						
8	screw plug	1	G1	G1	2	G1		G1		2	G 1 ½		1	318556
			309732	309732		309732		318556						
9	gasket	1	A 33 x 39	A 33 x 39	2	A 33 x 39		A 33 x 39		2	A 48 x 55		1	309764
			308257	308257		308257		309764						

### 4.2. Depending on the series:

item	qty.	designation	dimension	article-no.
10	1	clogging indicator, visual	OP	see sheet-no. 1628
11	1	clogging indicator, visual-electrical	OE	see sheet-no. 1628
12	1	clogging indicator, visual-electrical	AE	see sheet-no. 1609
13	1	clogging sensor, electrical	VS1	see sheet-no. 1607
14	1	clogging sensor, electrical	VS2	see sheet-no. 1608
15	2	O-ring	14 x 2	304342 (NBR)   304722 (FPM)
16	2	screw plug	G ½	309734
17	2	gasket	A 14 x 18	306330

## 5. Description:

In-line filters of the series LF 1211-10011 are suitable for a working pressure up to 10 bar. Pressure peaks can be absorbed with a sufficient margin of safety. The filter is in-line mounted. Inlet and outlet are on the same level. The filters can be installed as suction-filter, pressure-filter or return-line filter. The filter element consist of star-shaped, pleated filter material which is supported on the inside by a perforated core tube and is bonded to the end caps with a high-quality adhesive. The flow direction is from outside to the inside. The particles are hold back on the outside. For cleaning (see special leaflet 21070-4 resp. 39448-4) the mesh element respectively to change the glass fibre element remove the cover and take out the element. Filter finer than 40 µm should use throw-away elements made of paper or Interpor fleece (glass fibre). Filter elements as fine as 5 µm<sub>0.9</sub> are available; finer filter elements on request. INTERNORMEN-Filter elements are known as elements with a high intrinsic stability and an excellent filtration capability, a high dirt-retaining capacity and a long service life. INTERNORMEN-Filter are suitable for all petroleum based fluids, HW-emulsions, most synthetic hydraulic fluids and lubrication oils. Approvals according to TÜV, and the mayor „Shipyards Classification Societies“ D.N.V.; B.V.; G.L.; L.R.S.; R.I.N.A.; A.B.S.; P.R.S.;USS.R.S. and others are possible.

## 6. Technical data:

temperature range: - 10°C to +80°C (for a short time +100°C)  
operating medium: mineral oil, other media on request  
max. operating pressure: 10 bar  
test pressure: 14,3 bar  
connection system: flange connection DIN 2633, 16 bar (DN 50-150)  
flange connection DIN 2632, 10 bar (DN 200, 250)  
C-steel  
housing material: Nitrile (NBR) or Viton (FPM), other materials on request  
sealing material: Nitrile (NBR) or Viton (FPM), other materials on request  
installation position: vertical  
mini-measuring connection: G ¼ for screw coupling (mini-measuring)

Classified under the Pressure Equipment Directive 97/23/EC for mineral oil (fluid group 2), Article 3, Para. 3.  
Classified under ATEX Directive 94/9/EC according to specific application (see questionnaire sheet-no. 34279-4).

## 7. Symbols:

without indicator

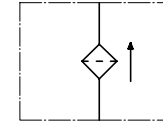

with electrical indicator  
AE 30 and AE 40

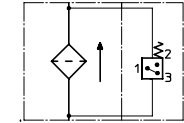

with visual -  
electrical indicator  
AE 50 and AE 62

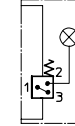

with visual -  
electrical indicator  
AE 70 and AE 80

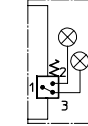

with visual  
indicator  
OP

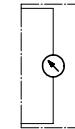

with visual -  
electrical indicator  
OE

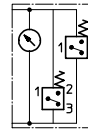

with electronical  
clogging sensor  
VS1

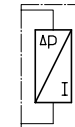

with electronical  
clogging sensor  
VS2

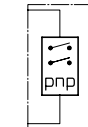

## 8. Pressure drop flow curves:

Precise flow rates see 'INT-Expert-System Filter', respectively Δp-curves; depending on filter fineness and viscosity.

## 9. Test methods:

Filter elements are tested according to the following ISO standards:

ISO 2941	Verification of collapse/burst resistance
ISO 2942	Verification of fabrication integrity
ISO 2943	Verification of material compatibility with fluids
ISO 3723	Method for end load test
ISO 3724	Verification of flow fatigue characteristics
ISO 3968	Evaluation of pressure drop versus flow characteristics
ISO 16889	Multi-pass method for evaluating filtration performance