

**STAINLESS STEEL-PRESSURE FILTER, change-over**  
**Series EDA 101 NPS 1" CLASS 150 PSI**

Sheet No.  
**2168 C**

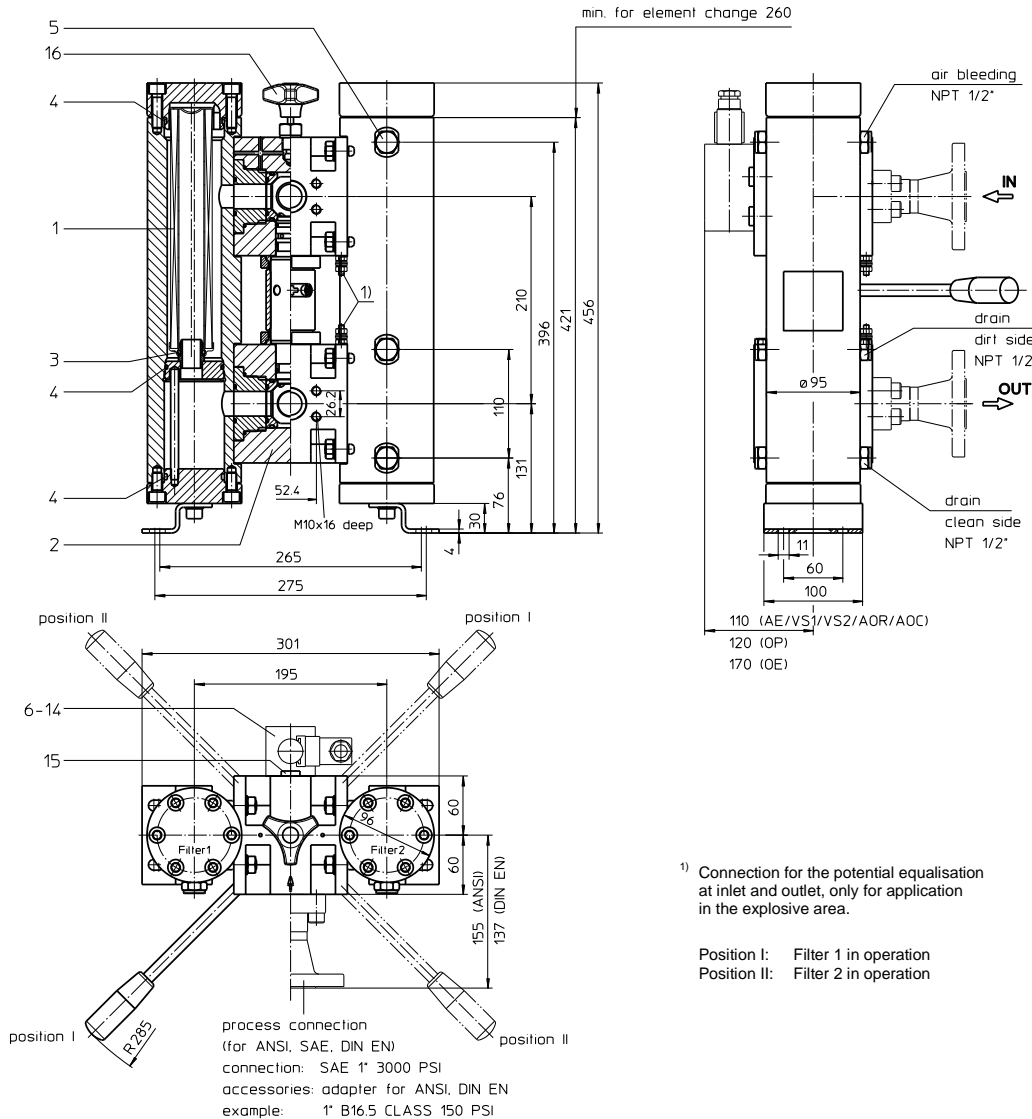

1) Connection for the potential equalisation at inlet and outlet, only for application in the explosive area.

Position I: Filter 1 in operation  
 Position II: Filter 2 in operation

**1. Type index:**

**1.1. Complete filter: (ordering example)**

**EDA. 101. 10VG. 30. E. P. VA. FS. 5. - . - . AE. AV. IS21. F. F**

1	2	3	4	5	6	7	8	9	10	11	12	13	14	15	16
---	---	---	---	---	---	---	---	---	----	----	----	----	----	----	----

- 1 | **series:**  
 EDA = stainless steel-pressure filter change-over, according to ASME-code
- 2 | **nominal size:** 101
- 3 | **filter-material and filter-fineness:**  
 80 G = 80 µm, 40 G = 40 µm, 25 G = 25 µm, 10 G = 10 µm stainless steel wire mesh  
 25 VG = 20 µm<sub>(c)</sub>, 16 VG = 15 µm<sub>(c)</sub>, 10 VG = 10 µm<sub>(c)</sub>, 6 VG = 7 µm<sub>(c)</sub>, 3 VG = 5 µm<sub>(c)</sub> Interpor fleece (glass fibre)  
 25 API = 20 µm, 10 API = 10 µm Interpor fleece (glass fibre) according to API  
 10 P = 10 µm paper
- 4 | **resistance of pressure difference for filter element:**  
 30 = Δp 30 bar
- 5 | **filter element design:**  
 E = single-end open, S = with by-pass valve Δp 2,0 bar, S1 = with by-pass valve Δp 3,5 bar
- 6 | **sealing material:**  
 P = Nitrile (NBR), V = Viton (FPM)
- 7 | **filter element specification:**  
 - = standard, VA = stainless steel
- 8 | **process connection:**  
 FS = SAE-flange connection 3000 PSI  
 FA11 = ANSI-flange connection CLASS 150 PSI, sealing surface R<sub>z</sub> = 160 µm (not finer than 40 µm)  
 FA12 = ANSI-flange connection CLASS 150 PSI, sealing surface R<sub>z</sub> = 16 µm  
 FD1 = flange connection DIN EN 1092-1, design B1  
 FD2 = flange connection DIN EN 1092-1, design B2
- 9 | **process connection size:**  
 5 = 1"
- 10 | **filter housing specification:** (material) see sheet-no. 55050  
 - = standard, per according to specification pressure vessel DGRL (1.4571) / ASME type 316L
- 11 | **internal valve:**  
 - = without
- 12 | **clogging indicator or clogging sensor:**  
 - = without, OP = visual, see sheet-no. 1628  
 AOR = visual, see sheet-no. 1606, OE = visual-electrical, see sheet-no. 1628  
 AOC = visual, see sheet-no. 1606, VS1 = electronical, see sheet-no. 1607  
 AE = visual-electrical, see sheet-no. 1609, VS2 = electronical, see sheet-no. 1608
- 13 | **shut-off valve:**  
 - = without, AV = shut-off valve, see sheet-no. 1655
- 14 | **specification pressure vessel:**  
 - = standard (PED 97/23/EC)  
 IS20 = ASME VIII Div.1 with ASME equivalent material, see sheet-no. 55217  
 IS21 = ASME VIII Div.1 with U-stamp, see sheet-no. 43415  
 IS23 = ASME VIII Div.1 without U-stamp, see sheet-no. 55218
- 15 | **switch lever:**  
 F = toward IN/OUT, B = opposite IN/OUT
- 16 | **air bleeding/drain:**  
 F = toward IN/OUT, B = opposite IN/OUT

**1.2. Filter element: (ordering example)**

**01NL. 100. 10VG. 30. E. P. VA**

1	2	3	4	5	6	7
---	---	---	---	---	---	---

- 1 | **series:**  
 01NL = standard filter element according to DIN 24550, T3
- 2 | **nominal size:** 100
- 3 | - 7 | see type index complete filter

weight: approx. 60 kg

Changes of measures and design are subject to alteration!

## 2. Accessories:

- SAE-counter flanges, see sheet-no. 1652
- adapter for connection acc. to EN1092-1, see sheet-no. 1657
- adapter for ANSI-connection B16.5 CLASS 150 PSI, see sheet-no. 1658
- measure- and bleeder-connections, see sheet-no. 1650
- drain- and bleeder connection, see sheet-no. 1659

## 3. Spare parts:

item	qty.	designation	dimension	article-no.	
1	2	filter element	01NL.100...		
2	1	change over UKK	DN 25		
3	2	O-ring	22 x 3,5	304341 (NBR)	304392 (FPM)
4	6	O-ring	54 x 3	304657 (NBR)	304720 (FPM)
5	12	screw plug	NPT 1/2	307766	
6	1	clogging indicator, visual	AOR or AOC	see sheet-no. 1606	
7	1	clogging indicator, visual-electrical	OP	see sheet-no. 1628	
8	1	clogging indicator, visual-electrical	OE	see sheet-no. 1628	
9	1	clogging indicator, visual-electrical	AE	see sheet-no. 1609	
10	1	clogging sensor, electronical	VS1	see sheet-no. 1607	
11	1	clogging sensor, electronical	VS2	see sheet-no. 1608	
12	1	O-ring	15 x 1,5	315357 (NBR)	315427 (FPM)
13	1	O-ring	22 x 2	304708 (NBR)	304721 (FPM)
14	2	O-ring	14 x 2	304342 (NBR)	304722 (FPM)
15	2	screw plug	G 1/4	306968	
16	1	pressure balance valve	DN 10	310316	
17	2	O-ring (only for execution with ANSI/DIN-flange)	32,9 x 3,53	318850 (NBR)	338231 (FPM)

item 15 execution only with clogging indicator or clogging sensor

## 4. Description:

Stainless steel-pressure filters, change-over series EDA 101 are suitable for operating pressure up to 40 bar.

Pressure peaks can be absorbed with a sufficient margin of safety.

Change-over ball valve which, integrated in the middle of the housing, makes it possible to switch from the dirty filter-side to the clean filter-side without interrupting operation.

The filter element consists of star-shaped, pleated filter material which is supported on the inside by a perforated core tube and is bonded to the end caps with a high-quality adhesive. The flow direction is from outside to the inside.

These filters can be installed as suction filters.

For cleaning (see special leaflet 21070-4 and 34448-4) the mesh element respectively to change the glass fibre element remove the cover and take out the element.

Filter finer than 40 µm should use throw-away elements made of paper or Interpor fleece (glass fibre). Filter elements as fine as 5 µm<sub>(c)</sub> are available; finer filter elements on request.

INTERNORMEN-Filter elements are known as elements with a high intrinsic stability and an excellent filtration capability, a high dirt-retaining capacity and a long service life.

INTERNORMEN-Filter are suitable for all petroleum based fluids, HW-emulsions, most synthetic hydraulic fluids and lubrication oils.

The inspection according to TÜV, according to ASME VIII Div.1 and the major „Shipyard Classification Societies“ D.N.V.; B.V.; G.L.; L.R.S.; R.I.N.A.; A.B.S. and others are possible. If inspection is required please indicate in your order.

## 5. Technical data:

temperature ranges

- calculation temperature (pressure vessel):

- 10°C to +100°C

- medium temperature:

- 10°C to +80°C

- ambient temperature:

- 40°C to +60°C

- survival temperature:

- 40°C to +100°C (short-time)

operating medium:

mineral oil, other media on request

max. operating pressure housing:

40 bar

test pressure acc. to PED 97/23/EC:

1,43 x operating pressure = 57 bar

test pressure acc. to ASME VIII Div. 1:

1,3 x operating pressure = 52 bar

test pressure acc. to API 614, Chapter 1:

1,5 x operating pressure = 60 bar

connection system:

SAE-flange connection 3000 PSI

housing material:

stainless steel, see sheet-no. 55050

sealing material:

Nitrile (NBR) or Viton (FPM), other materials on request

installation position:

vertical

bleeder connection :

NPT 1/2"

drain connection dirt side :

NPT 1/2"

drain connection clean side :

NPT 1/2"

volume tank :

2x 0,9 l

operating pressure adapter flanges:

according to B16.5 CLASS 150 PSI / DIN EN 1092-1

Classified under the Pressure Equipment Directive 97/23/EC for mineral oil (fluid group 2), Article 3, Para. 3.

Classified under ATEX Directive 94/9/EC according to specific application (see questionnaire sheet-no. 34279-4)

E 2168 C

## 6. Symbols:

without indicator

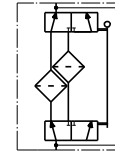

with shut-off valve

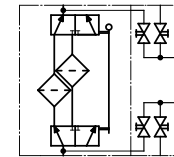

with by-pass valve

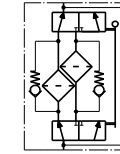

with electrical indicator  
AE 30 and AE 40

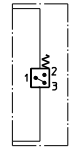

with visual-electrical indicator  
AE 50 and AE 62

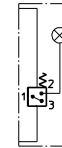

with visual-electrical indicator  
AE 70 and AE 80

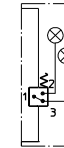

with visual indicator  
AOR/AOC/OP

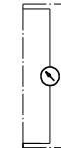

with visual-electrical indicator  
OE

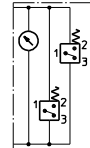

with electronical sensor  
VS1

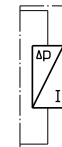

with electronical sensor  
VS2



## 7. Pressure drop flow curves:

Precise flow rates see 'INT-Expert-System Filter', respectively Δp- curves; depending on filter fineness and viscosity.

## 8. Test methods:

Filter elements are tested according to the following ISO standards:

ISO 2941	Verification of collapse/burst resistance
ISO 2942	Verification of fabrication integrity
ISO 2943	Verification of material compatibility with fluids
ISO 3723	Method for end load test
ISO 3724	Verification of flow fatigue characteristics
ISO 3968	Evaluation of pressure drop versus flow characteristics
ISO 16889	Multi-pass method for evaluating filtration performance