

PRESSURE FILTER, change-over ball valve
Series DU 635 DN 65 PN 32

Sheet No.
2128 E

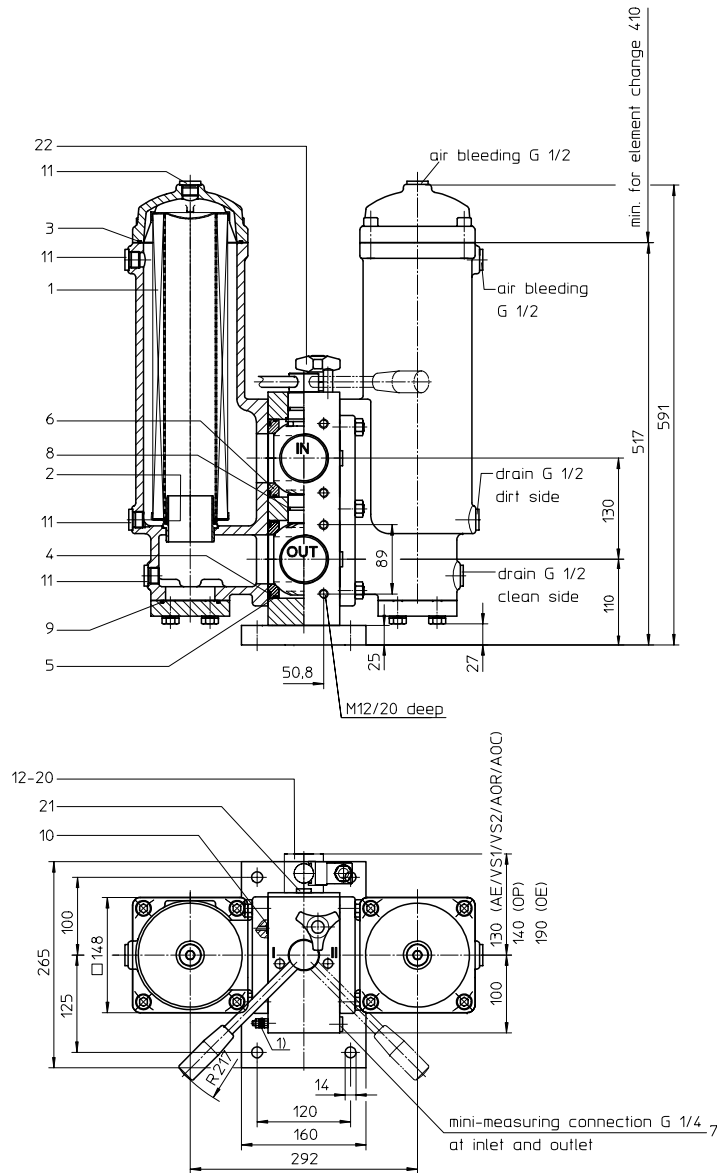

1) connection for the potential equitisation, at outlet, only for application in the explosive area

Pos. I: left filter-side in operation
 Pos. II: right filter-side in operation

1. Type index:

1.1. Complete filter: (ordering example)

DU. 635. 10VG. 30. E. P. -. FS. 9. -. -. AE

1	2	3	4	5	6	7	8	9	10	11	12
---	---	---	---	---	---	---	---	---	----	----	----

- 1 series:
DU = pressure filter, change-over
- 2 nominal size: 635
- 3 filter-material and filter-fineness:
80 G = 80 µm, 40 G = 40 µm, 25 G = 25 µm stainless steel wire mesh,
25 VG = 20 µm_(cl), 16 VG = 15 µm_(cl), 10 VG = 10 µm_(cl), 6 VG = 7 µm_(cl), 3 VG = 5 µm_(cl) Interpor fleece (glass fibre)
25 P = 25 µm, 10 P = 10 µm paper
- 4 resistance of pressure difference for filter element:
30 = Δp 30 bar
- 5 filter element design:
E = single-end open
S = with by-pass valve Δp 2,0 bar
S1 = with by-pass valve Δp 3,5 bar
- 6 sealing material:
P = Nitrile (NBR)
V = Viton (FPM)
- 7 filter element specification: (see catalog)
- = standard
VA = stainless steel
IS06 = see sheet-no. 31601
IS07 = see sheet-no. 31602
- 8 connection:
FS = SAE-flange connection 3000 PSI
- 9 connection size:
9 = 2 1/4 "
- 10 filter housing specification: (see catalog)
- = standard
IS06 = see sheet-no. 31605 IS12 = see sheet-no. 41028
- 11 internal valve:
- = without
- 12 clogging indicator or clogging sensor:
- = without, OP = visual, see sheet-no. 1628
AOR = visual, see sheet-no. 1606, OE = visual-electrical, see sheet-no. 1628
AOC = visual, see sheet-no. 1606, VS1 = electrical, see sheet-no. 1607
AE = visual-electrical, see sheet-no. 1609, VS2 = electrical, see sheet-no. 1608

1.2. Filter element: (ordering example)

01NL. 630. 10VG. 30. E. P. -

1	2	3	4	5	6	7
---	---	---	---	---	---	---

- 1 series:
01NL. = standard filter element according to DIN 24550, T3
- 2 nominal size: 630
- 3 - 7 see type index-complete filter

2. Accessories:

- measure- and bleeder connections, see sheet-no. 1650
- evacuation and bleeder-connections, see sheet-no. 1651
- counter flanges, see sheet-no. 1652
- shut-off valve, see sheet-no. 1655

weight: approx. 90 kg

Changes of measures and design are subject to alteration!



Friedensstrasse 41, 68804 Altlusheim, Germany

phone +49 - (0)6205 - 2094-0 e-mail sales@internormen.com
 fax +49 - (0)6205 - 2094-40 url www.internormen.com



3. Spare parts:

item	qty.	designation	dimension	article-no.	
1	2	filter element	01NL 630		
2	2	O-ring	60 x 3,5	304377 (NBR)	304398 (FPM)
3	2	O-ring	125 x 3	306025 (NBR)	307358 (FPM)
4	4	O-ring	85 x 4	305685 (NBR)	310285 (FPM)
5	4	O-ring	95 x 3	305808 (NBR)	304828 (FPM)
6	4	gasket		317651	
7	2	screw plug	G ¼	305003	
8	2	O-ring	32 x 3	304368 (NBR)	311020 (FPM)
9	2	O-ring	69,45 x 3,53	305868 (NBR)	307357 (FPM)
10	4	O-ring	8 x 2	310004 (NBR)	316530 (FPM)
11	8	screw plug	G ½	304678	
12	1	clogging indicator, visual	AOR oder AOC	see sheet no. 1606	
13	1	clogging indicator, visual	OP	see sheet no. 1628	
14	1	clogging indicator, visual-electrical	OE	see sheet no. 1628	
15	1	clogging indicator, visual-electrical	AE	see sheet no. 1609	
16	1	clogging sensor, electronical	VS1	see sheet no. 1607	
17	1	clogging sensor, electronical	VS2	see sheet no. 1608	
18	1	O-ring	15 x 1,5	315357 (NBR)	315427 (FPM)
19	1	O-ring	22 x 2	304708 (NBR)	304721 (FPM)
20	2	O-ring	14 x2	304342 (NBR)	304722 (FPM)
21	2	screw plug	G ¼	305003	
22	1	pressure balance valve			

item 21 execution only without clogging indicator or clogging sensor

4. Description:

Pressure filters, change-over series DU 635 are suitable for operating pressure up to 32 bar. Pressure peaks can be absorbed with a sufficient margin of safety. Change-over ball valve between the two filter housings makes it possible to switch from the dirty filter-side to the clean filter-side without interrupting operation.

The filter element consist of star-shaped, pleated filter material which is supported on the inside by a perforated core tube and is bonded to the end caps with a high-quality adhesive. The flow direction is from outside to the inside. These filters can be installed as suction filters. For cleaning (see special leaflet 21070-4 and 34448-4) the mesh element respectively to change the glass fibre element remove the cover and take out the element.

Filter finer than 40 µm should use throw-away elements made of paper or Interpor fleece (glass fibre). Filter elements as fine as 5 µm_(e) are available; finer filter elements on request.

INTERNORMEN-Filter elements are known as elements with a high intrinsic stability and an excellent filtration capability, a high dirt-retaining capacity and a long service life.

INTERNORMEN-Filter are suitable for all petroleum based fluids, HW-emulsions, most synthetic hydraulic fluids and lubrication oils.

Approvals according to TÜV, and the major „Shipyard Classification Societies“ D.N.V.; B.V.; G.L.; L.R.S.; R.I.N.A.; A.B.S. and others are possible.

5. Technical data:

temperature range:	- 10°C to + 80°C (for a short time + 100°C)
operating medium:	mineral oil, other media on request
max. operating pressure:	32 bar
test pressure:	64 bar
connection system:	SAE-flange connection 3000 PSI
housing material:	EN-GJS-400-18-LT
switching housing-material:	S355J2G3
sealing material:	Nitrile (NBR) or Viton (FPM), other materials on request
installation position:	vertical
mini-measuring connections:	G ¼
evacuation-or bleeder connections:	G ½
volume tank:	2x 5,7l

Classified under the Pressure Equipment Directive 97/23/EC for mineral oil (fluid group 2), Article 3, Para. 3.
Classified under ATEX Directive 94/9/EC according to specific application (see questionnaire sheet-no. 34279-4).

6. Symbols:

without indicator

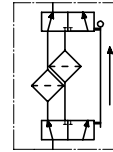

with electrical indicator
AE 30 and AE 40

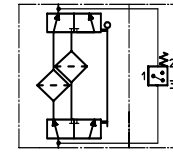

with visual-electrical indicator
AE 50 and AE 62

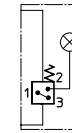

with visual-electrical indicator
AE 70 and AE 80

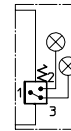

with visual indicator
AOR/AOC/OP

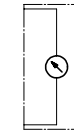

with visual-electrical indicator
OE

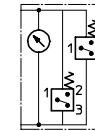

with electronical clogging sensor
VS1

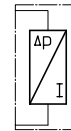

with electronical clogging sensor
VS2

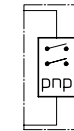

7. Pressure drop flow curves: Precise flow rates see 'INT-Expert-System Filter', respectively Δp-curves; depending on filter fineness and viscosity.

8. Test methods:

Filter elements are tested according to the following ISO standards:

ISO 2941	Verification of collapse/burst resistance
ISO 2942	Verification of fabrication integrity
ISO 2943	Verification of material compatibility with fluids
ISO 3723	Method for end load test
ISO 3724	Verification of flow fatigue characteristics
ISO 3968	Evaluation of pressure drop versus flow characteristics
ISO 16889	Multi-pass method for evaluating filtration performance