

PRESSURE FILTER, change-over
Series DU 101-401 DN 32-50 PN 32

Sheet No.
2117 N

1. Type index:

1.1. Complete filter: (ordering example)

DU. 251. 10VG. 30. E. P. -. FS. 8. -. -. AE

1	2	3	4	5	6	7	8	9	10	11	12
---	---	---	---	---	---	---	---	---	----	----	----

- 1 **series:**
DU = pressure filter, change-over
- 2 **nominal size:** 101, 251, 401
- 3 **filter-material and filter-fineness:**
80 G = 80 µm, 40 G = 40 µm, 25 G = 25 µm stainless steel wire mesh,
25 VG = 20 µm_(c), 16 VG = 15 µm_(c), 10 VG = 10 µm_(c), 6 VG = 7 µm_(c), 3 VG = 5 µm_(c) Interpor fleece (glass fibre)
25 P = 25 µm, 10 P = 10 µm paper
- 4 **resistance of pressure difference for filter element:**
16 = Δp 16 bar, (01.N 100), 30 = Δp 30 bar, (01NL. 250, 400)
- 5 **filter element design:**
E = single-end open
S = with by-pass valve Δp 2,0 bar
S1 = with by-pass valve Δp 3,5 bar
- 6 **sealing material:**
P = Nitrile (NBR), V = Viton (FPM)
- 7 **filter element specification:**
- = standard, VA = stainless steel, IS06 = see sheet-no. 31601
- 8 **connection:**
FS = SAE-flange connection 3000 PSI
- 9 **connection size:**
6 = 1 1/4" (DU 101), 8 = 2" (DU 251/401)
- 10 **filter housing specification:**
- = standard, IS12 = see sheet-no. 41028
- 11 **internal valve:**
- = without
- 12 **clogging indicator or clogging sensor:**
- = without, OP = visual, see sheet-no. 1628
AOR = visual, see sheet-no. 1606, OE = visual-electrical, see sheet-no. 1628
AOC = visual, see sheet-no. 1606, VS1 = electrical, see sheet-no. 1607
AE = visual-electrical, see sheet-no. 1609, VS2 = electrical, see sheet-no. 1608

1.2. Filter element: (ordering example)

01NL. 250. 10VG. 30. E. P. -

1	2	3	4	5	6	7
---	---	---	---	---	---	---

- 1 **series:**
01N. = standard filter element according to INTERNORMEN factory specification
01NL. = standard filter element according to DIN 24550, T3
- 2 **nominal size:** 100 (01N.); 250, 400 (01NL.)
- 3 - 7 | see type index-complete filter

2. Accessories:

- measure- and bleeder connections, see sheet-no. 1650
- evacuation and bleeder-connections, see sheet-no. 1651
- counter flanges, see sheet-no. 1652
- shut-off valve, see sheet-no. 1655

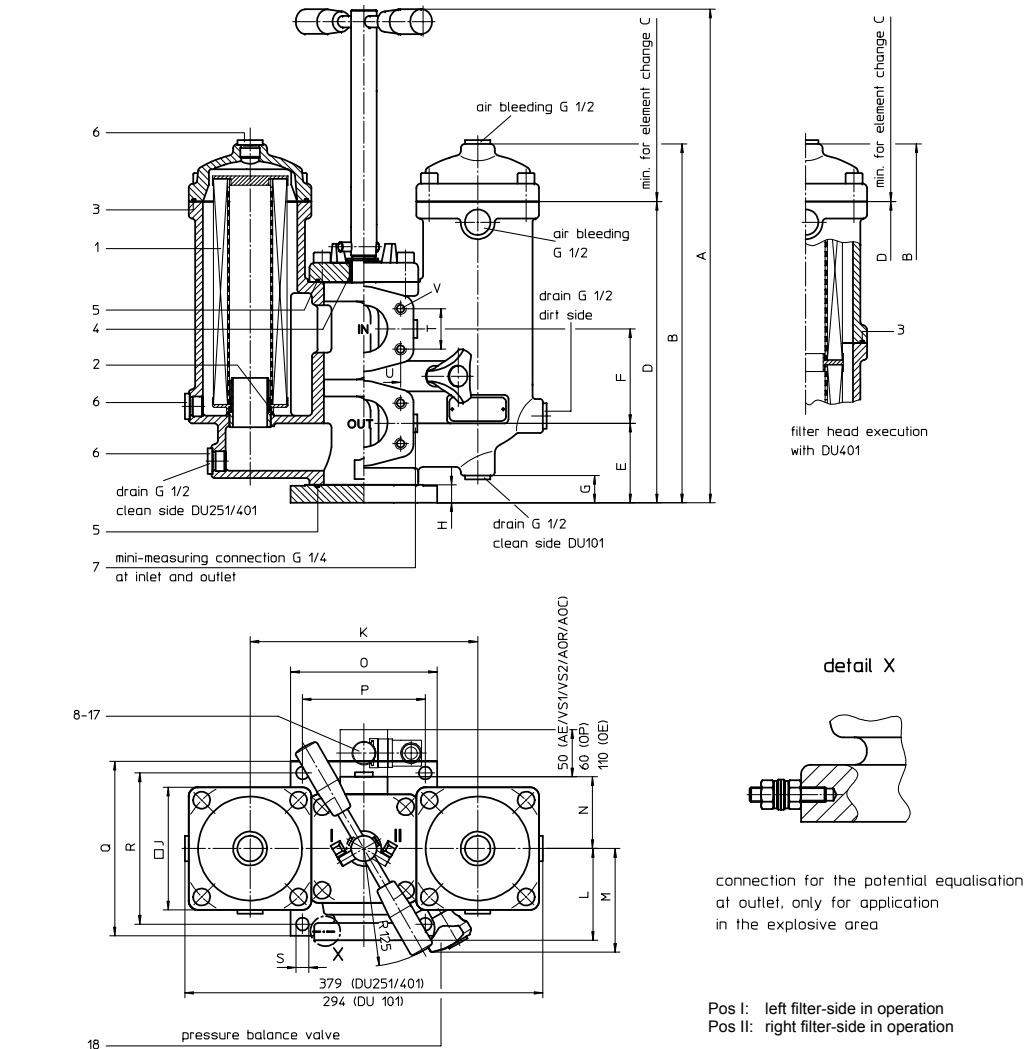

3. Dimensions:

type	connection	SAE-connection size	A	B	C	D	E	F	G	H	J	K	L	M	N	O	P	Q	R	S	T	U	V	weight kg
DU 101	DN 25 ¹⁾	SAE 1 1/4"	463	310	210	265	55	80	22	16	95	180	60	100	50	140	115	140	115	12	30,2	58,7	M10, 19 deep	23
DU 101	DN 32	SAE 1 1/4"																						
DU 251	DN 40 ²⁾	SAE 2"	522	380	260	319	84	100	-	19	130	241	97	110	76	155	130	185	160	13,5	42,9	77,8	M12, 18 deep	40
DU 251	DN 50	SAE 2"																						
DU 401	DN 50	SAE 2"	632	530	410	469	84	100	-	19	130	241	97	110	76	155	130	185	160	13,5	42,9	77,8	M12, 18 deep	50

¹⁾ by counter flange BFS.6.A.33,7x2,6.St.P.3000
²⁾ by counter flange BFS.8.A.48,3x3,7.St.P.3000

Instaed of P (Nitrile) also V (Viton) can be chosen.

Changes of measures and design are subject to alteration!



Friedensstrasse 41, 68804 Altlusheim, Germany

phone +49 - (0)6205 - 2094-0 e-mail sales@internormen.com
 fax +49 - (0)6205 - 2094-40 url www.internormen.com



4. Spare parts:

item	designation	qty.	dimension/article no. DU 101	qty.	dimension/article no. DU 251	qty.	dimension/article no. DU 401
1	filter element	2	01N. 100	2	01NL. 250	2	01NL. 400
2	O-ring	2	32 x 3,5 304378 (NBR) 304401 (FPM)	2	40 x 3 304389 (NBR) 304391 (FPM)	2	40 x 3 304389 (NBR) 304391 (FPM)
3	O-ring	2	76 x 4 305599 (NBR) 310291 (FPM)	2	115 x 3 303963 (NBR) 307762 (FPM)	4	115 x 3 303963 (NBR) 307762 (FPM)
4	O-ring	1	24 x 3 303038 (NBR) 304397 (FPM)	1	24 x 3 303038 (NBR) 304397 (FPM)	1	24 x 3 303038 (NBR) 304397 (FPM)
5	O-ring	2	60 x 2,5 305601 (NBR) 310267 (FPM)	2	95 x 3 305808 (NBR) 304828 (FPM)	2	95 x 3 305808 (NBR) 304828 (FPM)
6	screw plug	8	G ½ 304678				
7	screw plug	2	G ¼ 305003				
8	clogging indicator, visual	1	AOR or AOC see sheet-no. 1606				
9	clogging indicator, visual	1	OP see sheet-no. 1628				
10	clogging indicator, visual-electrical	1	OE see sheet-no. 1628				
11	clogging indicator, visual-electrical	1	AE see sheet-no. 1609				
12	clogging sensor, electronical	1	VS1 see sheet-no. 1607				
13	clogging sensor, electronical	1	VS2 see sheet-no. 1608				
14	O-ring	1	15 x 1,5	1	315357 (NBR) 315427 (FPM)		
15	O-ring	1	22 x 2	1	304708 (NBR) 304721 (FPM)		
16	O-ring	2	14 x 2	2	304342 (NBR) 304722 (FPM)		
17	screw plug	2	G ¼ 305003				
18	pressure balance valve	1					

item 17 execution only without clogging indicator or clogging sensor

5. Description:

Pressure filters, change-over series DU 101-401 are suitable for operating pressure up to 32 bar.

Pressure peaks can be absorbed with a sufficient margin of safety.

A three-way-change-over valve which is integrated in the middle of the housing makes it possible to switch from the dirty filter-side to the clean filter-side without interrupting operation.

The filter element consists of star-shaped, pleated filter material which is supported on the inside by a perforated core tube and is bonded to the end caps with a high-quality adhesive. The flow direction is from outside to the inside.

These filters can be installed as suction filters.

Filter finer than 40 µm should use throw-away elements made of paper or Interpor fleece (glass fibre). Filter elements as fine as 5 µm₀ are available; finer filter elements on request.

INTERNORMEN-Filter elements are known as elements with a high intrinsic stability and an excellent filtration capability, a high dirt-retaining capacity and a long service life.

INTERNORMEN-Filter are suitable for all petroleum based fluids, HW-emulsions, most synthetic hydraulic fluids and lubrication oils.

Approvals according to TÜV, and the major „Shipyard Classification Societies“ D.N.V.; B.V.; G.L.; L.R.S.; R.I.N.A.; A.B.S. and others are possible.

6. Technical data:

temperature range:
operating medium:
max. operating pressure:
test pressure:
connection system:
housing material:
sealing material:
installation position:
mini-measuring connections:
evacuation- or bleeder connections:
volume tank DU 101:
DU 251:
DU 401:

- 10°C to + 80°C (for a short time + 100°C)
mineral oil, other media on request
32 bar
64 bar
SAE-flange connection 3000 PSI
EN-GJS-400-18-LT
Nitrile (NBR) or Viton (FPM), other materials on request
vertical
G ¼
G ½
2x 0,9 l
2x 2,5 l
2x 3,7 l

Classified under the Pressure Equipment Directive 97/23/EC for mineral oil (fluid group 2), Article 3, Para. 3.
Classified under ATEX Directive 94/9/EC according to specific application (see questionnaire sheet-no. 34279-4)

7. Symbols:

without indicator

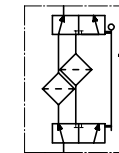

with electrical indicator
AE 30 and AE 40

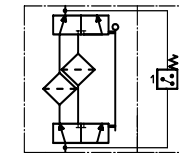

with visual -
electrical indicator
AE 50 and AE 62

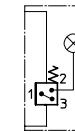

with visual -
electrical indicator
AE 70 and AE 80

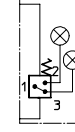

with visual
indicator
AOR/AOC/OP

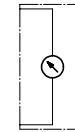

with visual -
electrical indicator
OE

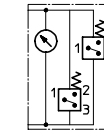

with electronical
clogging sensor
VS1

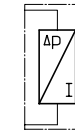

with electronical
clogging sensor
VS2

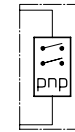

8. Pressure drop flow curves:

Precise flow rates see 'INT-Expert-System Filter', respectively Δp- curves; depending on filter fineness and viscosity.

9. Test methods:

Filter elements are tested according to the following ISO standards:

ISO 2941	Verification of collapse/burst resistance
ISO 2942	Verification of fabrication integrity
ISO 2943	Verification of material compatibility with fluids
ISO 3723	Method for end load test
ISO 3724	Verification of flow fatigue characteristics
ISO 3968	Evaluation of pressure drop versus flow characteristics
ISO 16889	Multi-pass method for evaluating filtration performance