

RETURN LINE FILTER, change-over

Series DTEF 1652

DN 100

PN 10

Sheet No.
1038 D

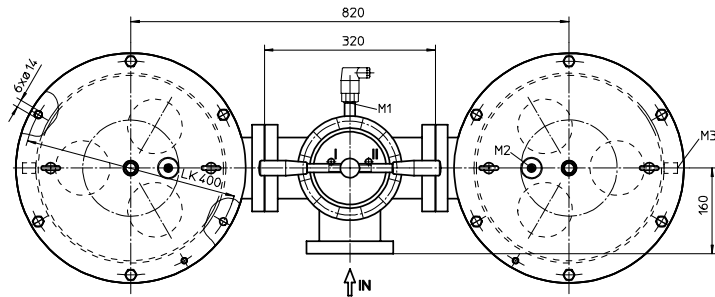
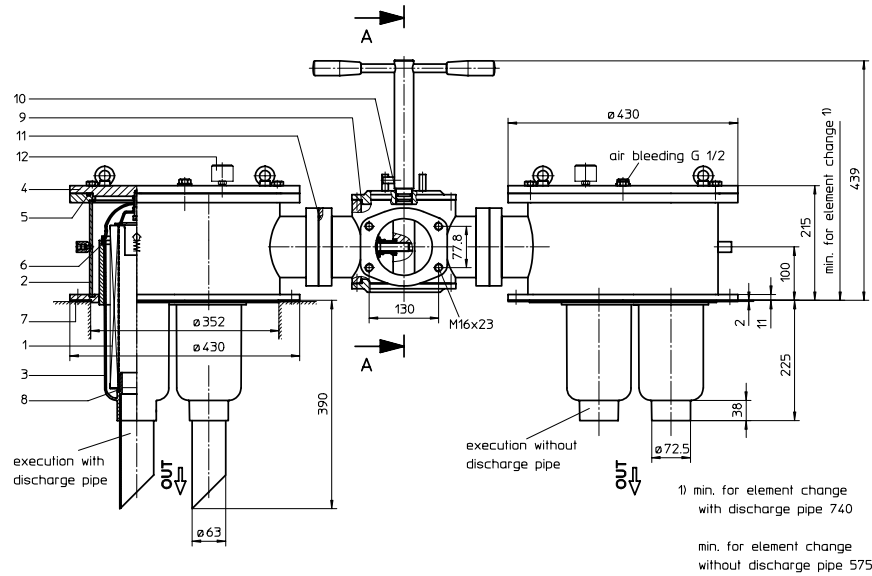

partial section A-A

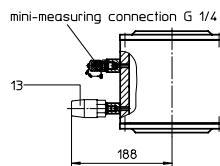

Position I: left filter-side in operation
Position II: right filter-side in operation

1. Type index:

1.1. Complete filter: (ordering example)

DTEF. 1652. 10VG. 16. S. P. -. FS. B. -. E1. O. -. -

1	2	3	4	5	6	7	8	9	10	11	12	13	14
---	---	---	---	---	---	---	---	---	----	----	----	----	----

- 1 series:
DTEF = tank-mounted return-line filter, change-over
- 2 nominal size: 1652
- 3 filter-material and filter-fineness:
80 G = 80 μ m, 40 G = 40 μ m, 25 G = 25 μ m stainless steel wire mesh,
25 VG = 20 μ m_(c), 16 VG = 15 μ m_(c), 10 VG = 10 μ m_(c), 6 VG = 7 μ m_(c), 3 VG = 5 μ m_(c) Interpor fleece (glass fiber)
25 P = 25 μ m, 10 P = 10 μ m paper
- 4 resistance of pressure difference for filter element:
16 = Δp 16 bar
- 5 filter element design:
E = without by-pass; S = with by-pass, Δp 2,0 bar
- 6 sealing material:
P = Nitrile (NBR); V = Viton (FPM)
- 7 filter element specification: (see catalog)
- = standard
VA = stainless steel
IS06 = see sheet-no. 31601
- 8 connection:
FS = SAE-flange connection 3000 PSI
- 9 connection size:
B = 4"
- 10 filter housing specification: (see catalog)
- = standard
IS06 = see sheet-no. 31605
- 11 clogging indicator at M1:
- = without
O = visual, see sheet-no. 1616
E1 = pressure switch, see sheet-no. 1616
E2 = pressure switch, see sheet-no. 1616
E5 = pressure switch, see sheet-no. 1616
- 12 clogging indicator at M2:
possible indicators see position 11 of the type index
- 13 clogging indicator at M3:
possible indicators see position 11 of the type index
- 14 discharge pipe:
- = without
1 = with discharge pipe

1.2. Filter element: (ordering example)

01E. 631. 10VG. 16. S. P. -

1	2	3	4	5	6	7
---	---	---	---	---	---	---

- 1 series:
01E. = filter element according to INTERNORMEN factory specification
- 2 nominal size: 631
- 3 - 7 see Type index-complete filter

2. Accessories:

- measure- and bleeder connections, see sheet-no. 1650
- evacuations- or bleeder connections, see sheet-no. 1651
- counter flange, see sheet-no.1652

weight: approx. 124 kg

Changes of measures and design are subject to alteration!



Friedensstrasse 41, 68804 Altlusheim, Germany

phone +49 - (0)6205 - 2094-0 e-mail sales@internormen.com
fax +49 - (0)6205 - 2094-40 url www.internormen.com



3. Spare parts:

item	qty.	designation	dimension	article-no.	
1	6	filter element	01.E 631	-	
2	2	filter head ¹⁾			
3	6	filter bowl with discharge pipe ¹⁾			
	6	filter bowl without discharge pipe ¹⁾			
4	2	filter cover ¹⁾			
5	2	O-ring	355 x 5	314740 (NBR)	314739 (FPM)
6	6	O-ring	120 x 4	305300 (NBR)	307991 (FPM)
7	2	gasket	430 x 350 x 2	317271 (NBR)	316659 (FPM)
8	2	O-ring	63 x 3,5	311189 (NBR)	311592 (FPM)
9	2	O-ring	150 x 4	313278 (NBR)	- (FPM)
10	2	O-ring	24 x 3	303038 (NBR)	304397 (FPM)
11	2	O-ring	110,72 x 3,53	316355 (NBR)	316356 (FPM)
12	1	clogging indicator, visual	O	see sheet-no. 1616	
13	1	pressure switch, electrical	E1, E2 or E5	see sheet-no. 1616	

¹⁾ in case of ordering these spare parts use the complete type index

4. Description:

Return-line filters change-over in the DTEF series are suitable for a working pressure up to 10 bar. Pressure peaks will be absorbed by a sufficient margin of safety. The DTEF-filters are directly mounted to the reservoir and connected to the return-line.

A rotary slide valve which is integrated in the middle of the housing makes it possible to switch from the dirty filter-side to the clean filter-side without interrupting operation.

The filter element consists of a star-shaped, pleated filter material which is supported on the inside by a perforated core tube and is bonded to the end caps with a high-quality adhesive. The flow is from outside to inside. Filters finer than 40 µm should use throw-away elements made of paper or Interpor fleece (glass fibre). Filter elements as fine as 5 µm (ø) are available; finer filter elements on request.

INTERNORMEN-Filters can be used for petroleum-based fluids, HW emulsions, water glycols, most synthetic fluids and lubrication fluids. Consult factory for specific fluid applications.

INTERNORMEN-Filters elements are known as stable elements which have excellent filtration capabilities and a high dirt retaining capacity, therefore having a long service life. Due to its practical design, the return-line filter is easy to service.

When changing the filter element a detachable connection between the filter head and the filter bowl prevents a flow back of dirty oil into the tank.

5. Technical data:

temperature range:	- 10°C to + 80°C (for a short time + 100°C)
operating medium:	mineral oil, other media on request
max. operating pressure:	10 bar
opening pressure by-pass valve:	2,0 bar
connection system:	SAE-flange connection 3000 PSI
housing material:	C-steel; glass fibre reinforced polyamide
sealing material:	Nitrile (NBR) or Viton (FPM), other materials on request
installation position:	vertical
volume tank:	2x 22,0 l

Classified under the Pressure Equipment Directive 97/23/EC for mineral oil (fluid group 2), Article 3, Para. 3.
Classified under ATEX Directive 94/9/EC according to specific application (see questionnaire sheet-no. 34279-4).

6. Symbols:

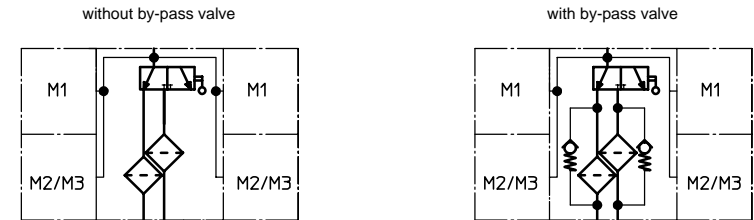

clogging indicator at M1, M2, M3

visual O

electrical contact maker E1

electrical contact breaker E5

electrical contact maker/breaker E2

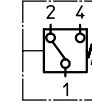
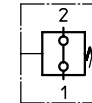
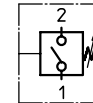
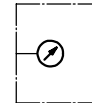

7. Pressure drop flow curves:

Precise flow rates see 'INT-Expert-System Filter', respectively Δp- curves; depending on filter fineness and viscosity.

8. Test methods:

Filter elements are tested according to the following ISO standards:

ISO 2941	Verification of collapse/burst resistance
ISO 2942	Verification of fabrication integrity
ISO 2943	Verification of material compatibility with fluids
ISO 3723	Method for end load test
ISO 3724	Verification of flow fatigue characteristics
ISO 3968	Evaluation of pressure drop versus flow characteristics
ISO 16889	Multi-pass method for evaluating filtration performance