

PRESSURE FILTER, change-over ball valve
Series DSF 1205-10005 DN 50-200 PN 16

Sheet No.
2134 G

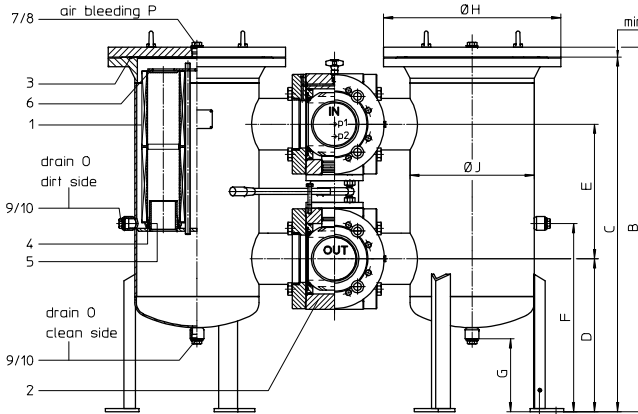

- 1) DSF 1205/2005/2405/3605 = 520mm
 DSF 4805/6005/10005 = 520mm
 DSF 3005 = 765mm
 DSF 4005 = 1020mm

Position I: filter 1 in operation
 Position II: filter 2 in operation
 Switch lever standard in the front

2) On request: Switch lever backside opposite to inlet and outlet.

Please specify on order!

3) connection for the potential equalisation at inlet and outlet resp. filter housing, only for application in the explosive area

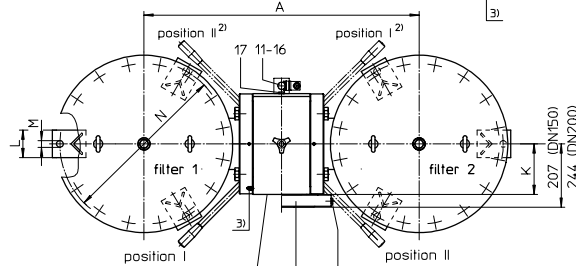

execution at connection SAE 3000 PSI DN 50-125
 mini-measuring connection G1/4 at inlet and outlet
 execution at connection DIN 2633 DN 150-200

3. Dimensions:

type	DN	A	B	C	D	E	F	G	H	J	K	L	M	N	O	P	weight kg	volume tank
DSF 1205	50	610	1009	985	365	175	480	185	340	219	74	70	18	330	G1	G ½	200	2x 26 l
	65	560	1009	985	365	270	460											2x 26 l
	80	585	1009	985	375	290	460											2x 26 l
	100	620	1024	1000	390	365	475											2x 26 l
	125	630	1011	985	380	270	460											2x 26 l
DSF 2005	65	630	1011	985	380	270	460	185	405	273	90	70	18	380	G1	G1	280	2x 39 l
	80	640	1011	985	380	290	460											2x 39 l
	100	670	1046	1020	400	365	495											2x 41 l
	125	730	1086	1060	420	395	535											2x 43 l
	150	680	1053	1025	390	270	480											2x 52 l
DSF 2405	80	700	1053	1025	400	290	480	185	460	324	100	70	18	450	G1	G1	355	2x 58 l
	100	730	1078	1050	410	365	505											2x 58 l
	125	770	1113	1085	425	395	540											2x 60 l
	150	760	1133	1107	420	440	535											2x 63 l
	175	780	1152	1120	480	290	575											2x 63 l
DSF 3005	65	630	1258	1232	380	270	460	185	405	273	100	70	18	380	G1	G ½	310	2x 52 l
	80	640	1258	1232	380	290	460											2x 52 l
	100	670	1293	1267	400	365	495											2x 54 l
	125	730	1333	1307	420	395	535											2x 56 l
	150	760	1333	1307	420	440	535											2x 57 l
DSF 3605	80	780	1152	1120	480	290	575	235	580	406	100	90	22	550	G1	G1	580	2x 97 l
	100	810	1152	1120	480	365	575											2x 97 l
	125	870	1192	1160	500	395	615											2x 103 l
	150	900	1192	1160	500	440	615											2x 103 l
	175	830	1506	1480	380	270	460											2x 103 l
DSF 4005	80	640	1506	1480	380	290	460	185	405	273	100	70	18	380	G1	G1	340	2x 65 l
	100	670	1541	1515	400	365	495											2x 65 l
	125	730	1581	1555	420	395	535											2x 67 l
	150	910	1216	1180	520	365	635											2x 69 l
	175	970	1216	1180	520	395	635											2x 165 l
DSF 4805	150	1040	1236	1200	530	440	655	235	715	508	100	90	22	650	G1	G1	800	2x 165 l
	200	1090	1376	1340	560	520	795											2x 165 l
	250	1170	1350	1310	630	395	765											2x 171 l
DSF 6005	125	1170	1350	1310	630	395	765	285	910	711	142	120	22	900	G1 ½	G1 ½	950	2x 197 l
	150	1250	1350	1310	630	440	765											2x 358 l
	200	1290	1490	1450	660	520	905											2x 358 l
DSF 10005	125	1170	1350	1310	630	395	765	285	910	711	142	120	22	900	G1 ½	G1 ½	950	2x 408 l
	150	1250	1350	1310	630	440	765											2x 358 l
	200	1290	1490	1450	660	520	905											2x 408 l

EDV 04/09

1. Type index:

1.1. Complete filter: (ordering example)

DSF. 3605. 10VG. 10. E. P. -. FS. B. -. AE

1	2	3	4	5	6	7	8	9	10	11
---	---	---	---	---	---	---	---	---	----	----

- 1) **series:**
 DSF = duplex filter
- 2) **nominal size:** 1205, 2005, 2405, 3005, 3605, 4005, 4805, 6005, 10005
- 3) **filter-material and filter-fineness:**
 80 G = 80 µm, 40 G = 40 µm, 25 G = 25 µm, 10 G = 10 µm stainless steel wire mesh,
 25 VG = 20 µm_(c), 16 VG = 15 µm_(c), 10 VG = 10 µm_(c), 6 VG = 7 µm_(c), 3 VG = 5 µm_(c), Interpor fleece (glass fibre)
 25 P = 25 µm, 10 P = 10 µm paper
- 4) **resistance of pressure difference for filter element:**
 10 = Δp 10 bar
- 5) **filter element design:**
 E = without by-pass valve S = with by-pass valve Δp 2,0 bar
- 6) **sealing material:**
 P = Nitrile (NBR) V = Viton (FPM)
- 7) **filter element specification: (see catalog)**
 - = standard
 VA = stainless steel
 IS06 = see sheet-no. 31601
- 8) **connection:**
 FS = flange connection SAE 3000 PSI, only for DN 50-125
 FD1 = flange connection DIN 2633, design C DIN 2526, only for DN 150-200
 FD2 = flange connection DIN 2633, design E DIN 2526, only for DN 150-200
- 9) **connection size:**

filter-nominal size	DSF 1205	DSF 2005	DSF 2405	DSF 3005	DSF 3605
connection size	8-9-A-B	9-A-B-C	9-A-B-C	9-A-B-C-D	A-B-C-D
filter-nominal size	DSF 4005	DSF 4805	DSF 6005	DSF 10005	
connection size	9-A-B-C	B-C-D-E	B-C-D-E	C-D-E	

8 = DN 50 9 = DN 65 A = DN 80 B = DN 100 C = DN 125 D = DN 150 E = DN 200

- 10) **filter housing specification: (see catalog)**
 - = standard
 IS06 = see sheet-no. 31605
- 11) **clogging indicator or clogging sensor:**
 - = without AE = visual-electrical, see sheet-no. 1609
 OP = visual, see sheet-no. 1628 VS1 = electrical, see sheet-no. 1607
 OE = visual-electrical, see sheet-no. 1628 VS2 = electrical, see sheet-no. 1608

1.2. Filter element: (ordering example)

01E. 1201. 10VG. 10. E. P. -

1	2	3	4	5	6	7
---	---	---	---	---	---	---

- 1) **series:**
 01E. = filter element according to INTERNORMEN factory specification
- 2) **Nenngröße:** 1201, 2001, 3001, 4001
- 3) **- 7** see type index-complete filter

2. Accessories:

- measure -and bleeder-connections, see sheet-no. 1650
- evacuation- and bleeder-connections, see sheet-no. 1651
- shut-off valve, see sheet-no. 1655
- SAE-counter flanges, see sheet-no. 1652
- adaptor for flange DIN 2633 (DN 50-125), see sheet-no. 1657
- lifting mechanism, see sheet-no. 1661

Changes of measures and design are subject to alteration!



Friedensstrasse 41, 68804 Altlusheim, Germany

phone +49 - (0)6205 - 2094-0 e-mail sales@internormen.com
 fax +49 - (0)6205 - 2094-40 url www.internormen.com



4. Spare parts:

4.1. Depending on different series:

item	designation	qty.	dimension and article-no. DSF 1205	dimension and article-no. DSF 2005	qty.	dimension and article-no. DSF 2405	qty.	dimension and article-no. DSF 3005	qty.	dimension and article-no. DSF 3605	qty.	dimension and article-no. DSF 4005	qty.	dimension and article-no. DSF 4805	qty.	dimension and article-no. DSF 6005	dimension and article-no. DSF 10005	
1	filter element	2	01E.1201	01E.2001	4	01E.1201	2	01E.3001	6	01E.1201	2	01E.4001	8	01E.1201	6	01E.2001	10	01E.2001
2	change over UKK	1	DN 50-100	DN 65-125	1	DN 65-125	1	DN 65-150	1	DN 80-150	1	DN 65-125	1	DN 100-200	1	DN 100-200	1	DN 125-200
3	O-ring	2	225 x 5 308652 (NBR) 311473 (FPM)	275 x 5 307414 (NBR) 310288 (FPM)	2	330 x 5 303080 (NBR) 310275 (FPM)	2	275 x 5 307414 (NBR) 310275 (FPM)	2	429 x 6 308659 (NBR) 310273 (FPM)	2	275 x 5 307414 (NBR) 310288 (FPM)	2	516 x 6 301962 (NBR) 311474 (FPM)	2	516 x 6 301962 (NBR) 311474 (FPM)	2	722 x 8 308145 (NBR) 311805 (FPM)
4	O-ring	2	85 x 10 304386 (NBR) 304541 (FPM)	125 x 10 304388 (NBR) 306006 (FPM)	4	85 x 10 304386 (NBR) 304541 (FPM)	2	125 x 10 304388 (NBR) 306006 (FPM)	6	85 x 10 304386 (NBR) 304541 (FPM)	2	125 x 10 304388 (NBR) 306006 (FPM)	8	85 x 10 304386 (NBR) 304541 (FPM)	6	125 x 10 304388 (NBR) 306006 (FPM)	10	125 x 10 304388 (NBR) 306006 (FPM)
5	O-ring	2	93 x 5 307588 (NBR) 307589 (FPM)	135 x 5 306016 (NBR) 307045 (FPM)	4	93 x 5 307588 (NBR) 307589 (FPM)	2	135 x 5 306016 (NBR) 307045 (FPM)	6	93 x 5 307588 (NBR) 307589 (FPM)	2	135 x 5 306016 (NBR) 307045 (FPM)	8	93 x 5 307588 (NBR) 307589 (FPM)	6	135 x 5 306016 (NBR) 307045 (FPM)	10	135 x 5 306016 (NBR) 307045 (FPM)
6	spring	2	Da = 95 304414	Da = 95 304414	2	pressure plate	2	Da = 95 304414	2	pressure plate	2	Da = 95 304414	2	pressure plate	2	pressure plate	2	pressure plate
7	screw plug	2	G ½ 309730	G 1 309732	2	G1 309732											2	G 1 ½ 318556
8	gasket	2	A 22 x 27 305564	A 33 x 39 308257	2	A 33 x 39 308257											2	A 48 x 55 309764
9	screw plug	4	G1 309732	G1 309732	4	G1 309732											4	G 1 ½ 318556
10	gasket	4	A 33 x 39 308257	A 33 x 39 308257	4	A 33 x 39 308257											4	A 48 x 55 309764

4.2. Depending on the series:

item	qty.	designation	dimension	article-no.
11	1	clogging indicator, visual	OP	see sheet-no. 1628
12	1	clogging indicator, visual-electrical	OE	see sheet-no. 1628
13	1	clogging indicator, visual-electrical	AE	see sheet-no. 1609
14	1	clogging sensor, electronical	VS1	see sheet-no. 1607
15	1	clogging sensor, electronical	VS2	see sheet-no. 1608
16	2	O-ring	14 x 2	304342 (NBR)
17	2	screw plug	G ½	305003

Item 17 execution only without clogging indicator or clogging sensor

5. Description:

Duplex filters of the series DSF 1205 - 10005 are suitable for a working pressure up to 16 bar.

Pressure peaks can be absorbed with a sufficient margin of safety.

Change-over ball valve between the two filter housings makes it possible to switch from the dirty filter-side to the clean filter-side without interrupting operation.

The filters can be installed as suction filter, pressure filter or return-line filter.

The filter element consist of star-shaped, pleated filter material which is supported on the inside by a perforated core tube and is bonded to the end caps with a high-quality adhesive. The flow direction is from outside to the inside.

For cleaning (see special leaflet 21070-4 and 34448-4) the mesh element respectively to change the glass fibre element remove the cover and take out the element.

Filter finer than 40 µm should use throw-away elements made of paper or Interpor fleece (glass fibre). Filter elements as fine as 5 µm_(c) are available; finer filter elements on request.

INTERNORMEN-Filter elements are known as elements with a high intrinsic stability and an excellent filtration capability, a high dirt-retaining capacity and a long service life.

INTERNORMEN-Filter are suitable for all petroleum based fluids, HW-emulsions, most synthetic hydraulic fluids and lubrication oils.

Approvals according to TÜV, and the major „Shipyards Classification Societies“ D.N.V.; B.V.; G.L.; L.R.S.; R.I.N.A.; A.B.S.; P.R.S.; USS.R.S. and others are possible.

6. Technical data:

temperature range:	- 10°C to + 80°C (for a short time + 100°C)
operating medium:	mineral oil, other media on request
max. operating pressure:	16 bar
test pressure:	23 bar
connection system:	SAE-flange connection 3000 PSI or flange connection DIN 2633, 16 bar
housing material:	C-steel
sealing material:	Nitrile (NBR) or Viton (FPM), other materials on request
installation position:	vertical
mini-measuring connection:	G ¼

Classified under the Pressure Equipment Directive 97/23/EC for mineral oil (fluid group 2), Article 3, Para. 3.

Classified under ATEX Directive 94/9/EC according to specific application (see questionnaire sheet-no. 34279-4).

E 2134 G

7. Symbols:

without indicator

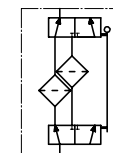

with visual - electrical indicator
AE 50 and AE 62

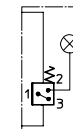

with visual indicator
OP

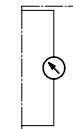

with electron ical clogging sensor
VS1

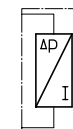

with electrical indicator
AE 30 and AE 40

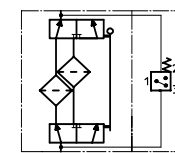

with visual - electrical indicator
AE 70 and AE 80

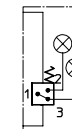

with visual - electrical indicator
OE

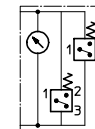

with electronical clogging sensor
VS2

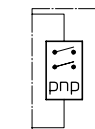

8. Pressure drop flow curves:

Precise flow rates see 'INT-Expert-System Filter', respectively Δp-curves; depending on filter fineness and viscosity.

9. Test methods:

Filter elements are tested according to the following ISO standards:

ISO 2941	Verification of collapse/burst resistance
ISO 2942	Verification of fabrication integrity
ISO 2943	Verification of material compatibility with fluids
ISO 3723	Method for end load test
ISO 3724	Verification of flow fatigue characteristics
ISO 3968	Evaluation of pressure drop versus flow characteristics
ISO 16889	Multi-pass method for evaluating filtration performance