

Directional spool valve types

WMM10 hand lever operated

WMD10 rotary knob operated

WMR10 roller operated

WH10 hydraulically operated

**WK
420 180**

NS10

31,5 MPa

120 dm³/min

04.2009

APPLICATION

Directional spool valves are intended for change in direction of fluid flow in a hydraulic system and thus it allows to change direction of movement of a receiver - mostly piston rod of a cylinder or hydraulic motor as well to use functions: *on* and *off*. These directional spool valves are used for subplate mounting in any position in a hydraulic system.

Directional spool valves can be made in differently operated design versions:

- hand lever operated type **WMM10**
- rotary knob operated type **WMD10**
- roller operated type **WMR10**
- hydraulically operated type **WH10**

The directional valves are intended for subplate mounting in any position in hydraulic system.

DESCRIPTION OF OPERATION

General information

Main bore and annular ports **P**, **T**, **A**, **B** are made in the housing (1) and connected to its subplate connection. Directional valve is switched by shifting the spool (2) into one end position. Various control functions result from the shape of control spool (2) which affects the change in configuration of the connections between ports **P**, **T**, **A** and **B** in the housing (1).

Directional spool valve - hand lever operated type **WMM10**

The spool (2) is shifted by changing the position of hand lever (3) by means of the pin (4). The spool return (2) to its rest position is secured by centering springs (5) – version ...WMM10...-12/... . Positions of the spool can be fixed by means of the detent (6) as well – version ...WMM10...-12/F... Directional spool valve may be provided with the orifice (7) placed in port **P** – version ...WMM10 -12/...B.

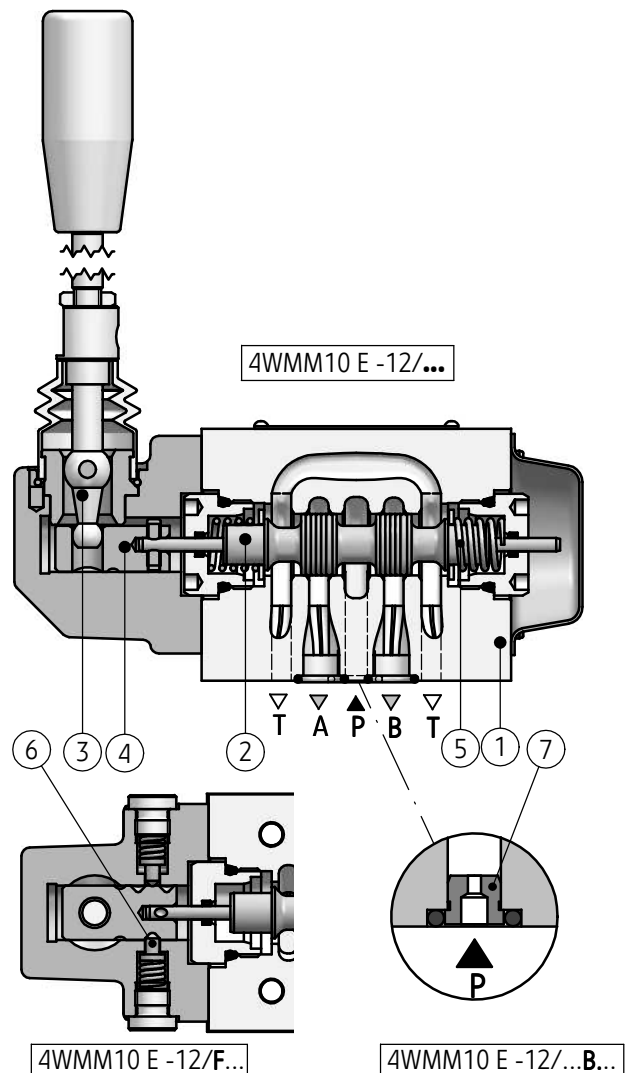

DESCRIPTION OF OPERATION

Directional spool valves - rotary knob operated type WMD10

The spool (2) is shifted by means of rotary knob (3) through the spindle (4) and by means of the plunger (5). The spool is positioned by means of detent (6). Directional spool valve may be provided with orifice (7) placed in port P – version ...WMD10...-12/FB.

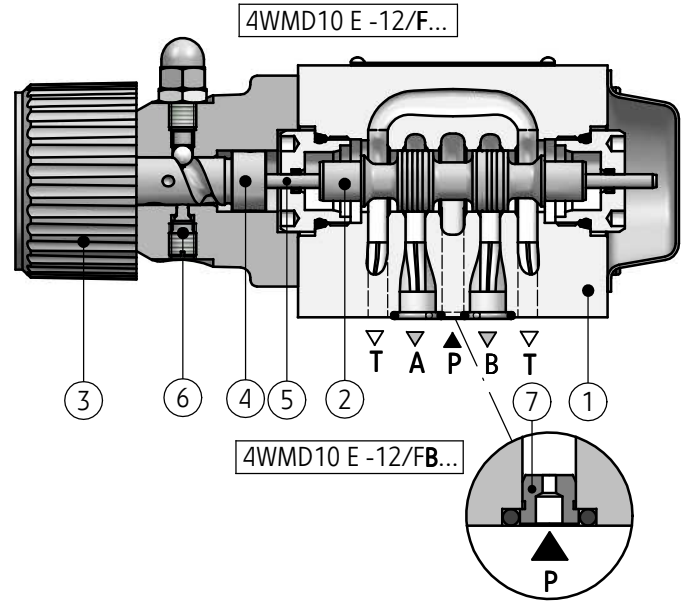

Directional spool valve - roller operated type WMR10/WMU10

The spool (2) is shifted by means of the pin (3) with the roller (4) at the end of pin, through the plunger (5). Spool return (2) to its rest position is secured by the spring (6) – version ...WMR10...-12/... The roller (4) may be mounted horizontally or vertically. The change of position is secured by rotating the pin (3) with roller (4). Screw (8) serves to fix position of the pin (3). Directional spool valve may be provided with orifice (7) placed in port P – version ...WMR...-12/...B....

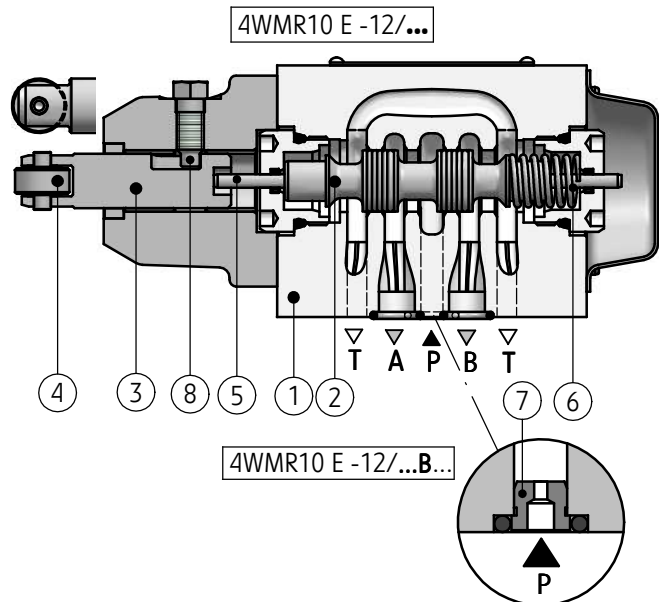

Directional spool valve - hydraulically operated type WH10

The spool (2) is shifted by means of the pressure supplied to connections of the caps (3) and thus it allows to move spools (4) and plunger (5). Spool return (2) and its centering in neutral position (3-position directional valves) is secured by the springs (6) – version ...WH10...-12/... or fixing end positions of the spool (2-position directional valves) is secured hydraulically (with oil pressure) – version ...WH6...-12/O... or by means of detent – version ...WH6...-12/OF.... Directional spool valve may be provided with orifice (7) placed in port P – version ...WH6...-12/...B.

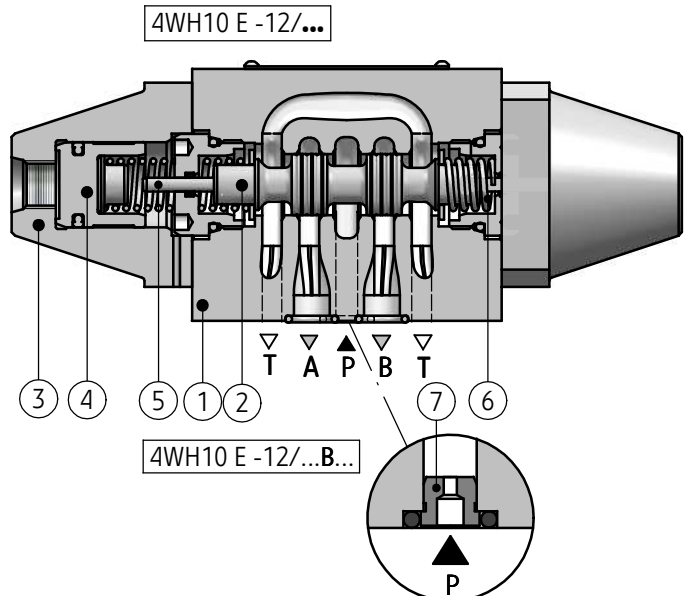

TECHNICAL DATA

Hydraulic fluid	mineral oil							
Required filtration	up to 16 µm							
Recommended filtration	up to 10 µm							
Nominal fluid viscosity	37 mm ² /s at temperature 55 °C							
Viscosity range	2,8 up to 380 mm ² /s							
Fluid temperature range (in a tank)	recommended	40 °C up to 55 °C						
	max	-20 °C up to +70 °C						
Ambient temperature range	- 20 °C up to +70 °C							
Features	type WMM10		type WMD10		type WMR10		type WH10	
Max operating pressure	ports		ports		ports		ports	
	P, A, B	T	P, A, B	T	P, A, B	T	P, A, B	T
	31,5 MPa	16 MPa	31,5 MPa	16 MPa	31,5 MPa	16 MPa	31,5 MPa	16 MPa
Control pressure	—		—		—		min 0,5 MPa	
	—		—		—		max 6,0 MPa	
Switching force	spring centering 20 - 27 N		—		2-position version 70 -120 N		—	
	positioned with detent 16 - 23 N		—		3-position version 70 -160 N		—	
Tightening torque of rotary knob	—		70 - 135 Ncm		—		—	
Max angle of control cam	—		—		30°		—	
Weight	4 kg		3,7 kg		3,6 kg		version with 2 control ports 3,8 kg	
	4 kg		3,7 kg		3,6 kg		version with 1 control port 3,4 kg	
Flow section in θ (central) position	spool type		Q		W		V	
	flow direction		A → T B → T		A → T B → T		A → T P → A B → T P → B	
	flow section		5,5 mm ²		2,5 mm ²		11 mm ² 10 mm ²	

SCHEMES

Directional spool valve - hand lever operated type ...WMM10...-1X/...

Graphic symbols of 3-position
directional spool valves

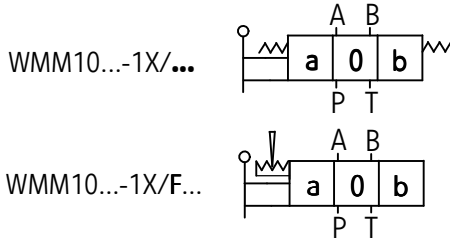

Graphic symbols of 2-position
directional spool valves

versions with positions a, 0

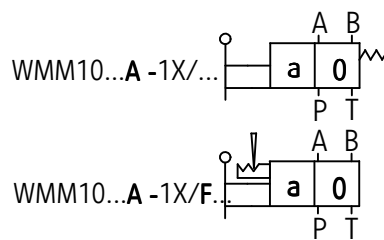

versions with positions 0, b

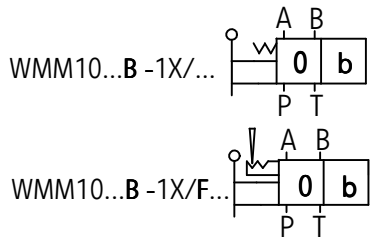

Graphic symbols of spools

working
and indirect
positions

working
positions

working
and indirect
positions

working
positions

working
and indirect
positions

working
positions

working and indirect positions	working positions	working and indirect positions	working positions	working and indirect positions	working positions

NOTE:

Flow sections in 0 (central) position for spools:
Q, W, V according to technical data on page 3

SCHEMES

Directional spool valve - hand lever operated type ...WMM10...-1X/...

Graphic symbols of 2-position directional spool valves

versions with positions a, b

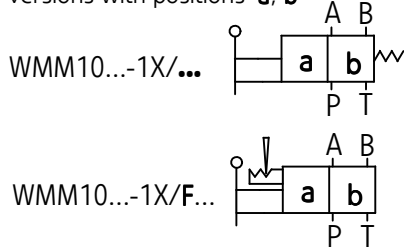

versions with positions a, b

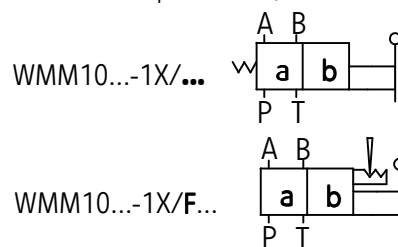

Graphic symbols of spools

working
and indirect
positions

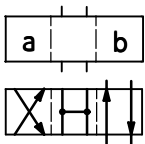
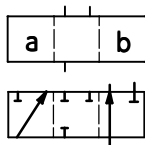

working
positions

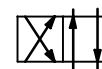
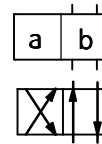
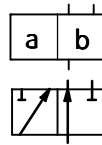

A

C

D

working
and indirect
positions

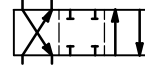
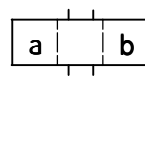
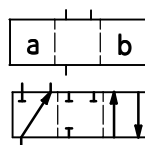

working
positions

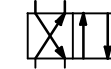
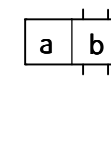
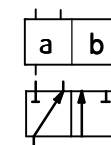

B

Y

Directional spool valve - rotary knob operated type ... WMD10...-1X/...

Graphic symbols of 2-position directional spool valves

versions with positions a, b

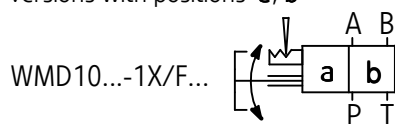

Graphic symbols of spools

working
and indirect
positions

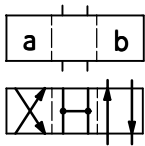
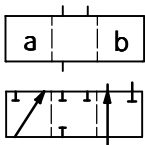

working
positions

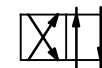
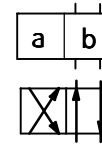
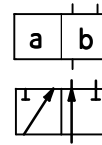

A

C

D

SCHEMES

Directional spool valve - rotary knob operated type ... WMD10...-1X/...

Graphic symbols of 3-position
directional spool valves

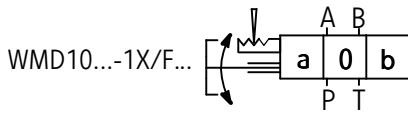

Graphic symbols of 2-position
directional spool valves

versions with positions a, 0

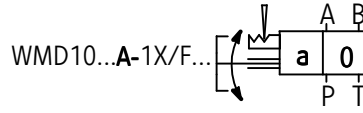

versions with positions 0, b

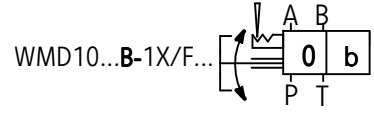

Graphic symbols of spools

working
and indirect
positions

working
positions

working
and indirect
positions

working
positions

working
and indirect
positions

working
positions

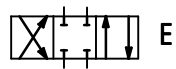
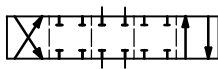
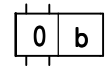
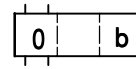
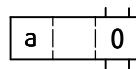
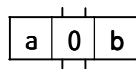
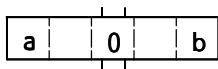

E

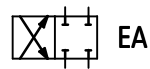

EA

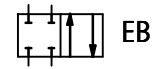
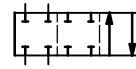

EB

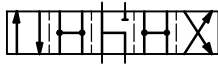

F

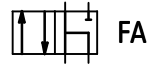

FA

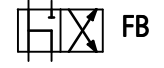

FB

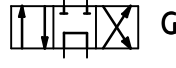
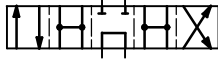

G

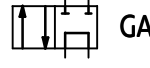

GA

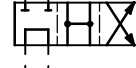

GB

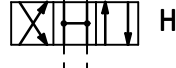

H

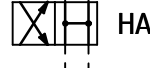

HA

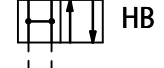

HB

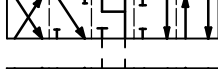

J

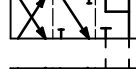

JA

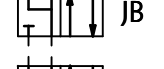

JB



L

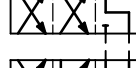

LA

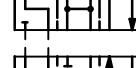

LB

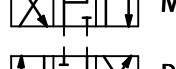
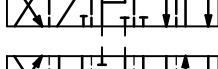

M

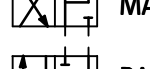
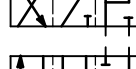

MA

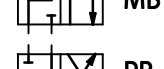

MB

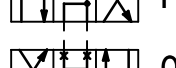
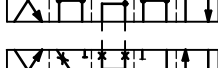

P

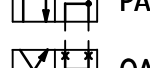

PA



PB

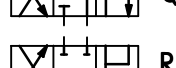
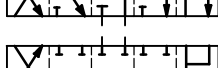

Q

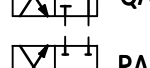
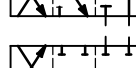

QA

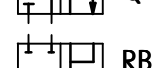

QB

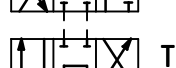
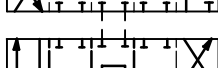

R

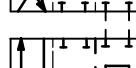

RA

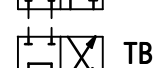

RB



T

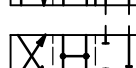

TA

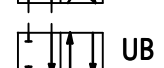

TB

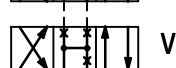
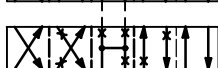

U

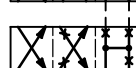

UA

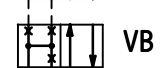
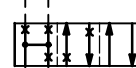

UB

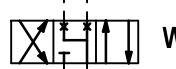
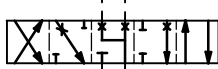

V

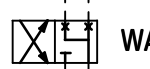

VA

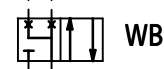
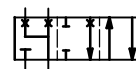

VB



W



WA



WB

NOTE:

Flow sections in 0 (central) position for spools:
Q, W, V according to technical data on page 3

SCHEMES

Directional spool valve - roller operated type ... WMR10...-1X/...

Graphic symbols of 3-position directional spool valves

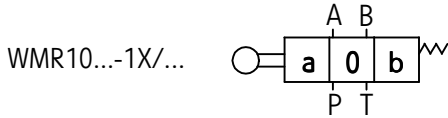

Graphic symbols of 2-position directional spool valves

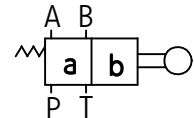
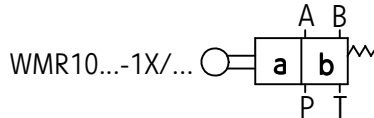

Graphic symbols of spools

working and indirect positions

working positions

working and indirect positions

working positions

working and indirect positions

working positions

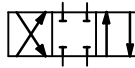
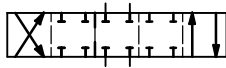
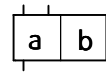
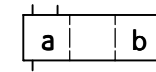
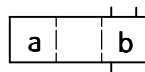
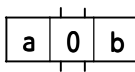
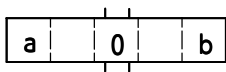

E

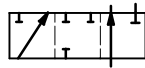

A

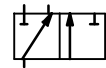
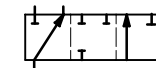

B

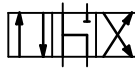
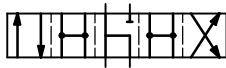

F

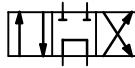
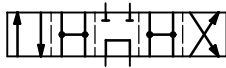

G

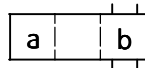

C

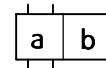
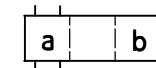

D

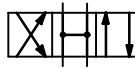
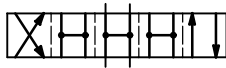

H



Y



Y

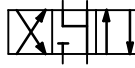

J



L

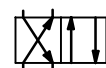
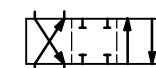

M

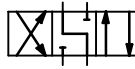

L

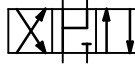
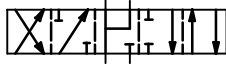

M

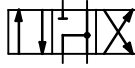
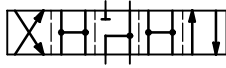

P

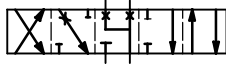

Q

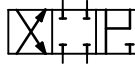
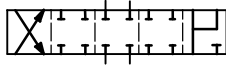

R

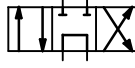
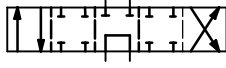

T

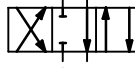
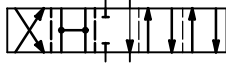

U

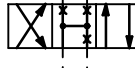
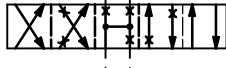

V



W

NOTE:

Flow sections in 0 (central) position for spools: Q, W, V according to technical data on page 3

SCHEMES

Directional spool valve - hydraulically operated type ...WH10...-1X/...

Graphic symbols of 3-position
directional spool valves

WH10...-1X/...

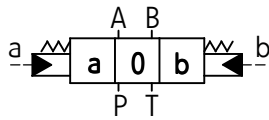

Graphic symbols of 2-position
directional spool valves

versions with positions a, 0

WH10...A-1X/...

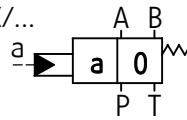

versions with positions 0, b

WH10...B-1X/...

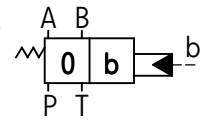

Graphic symbols of spools

working
and indirect
positions

working
positions

working
and indirect
positions

working
positions

working
and indirect
positions

working
positions

working and indirect positions	working positions	working and indirect positions	working positions	working and indirect positions	working positions

NOTE:

Flow sections in 0 (central) position for spools:
Q, W, V according to technical data on page 3

SCHEMES

Directional spool valve - hydraulically operated type ...WH10...-1X/...

Graphic symbols of 2-position directional spool valves

versions with positions **a, b**

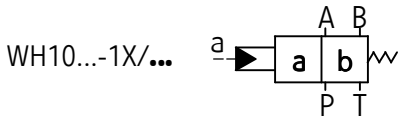

versions with positions **a, b**

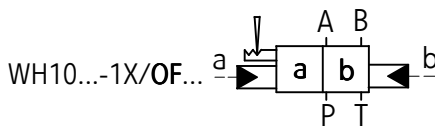
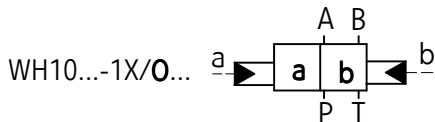
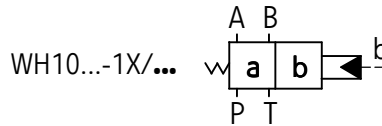

Graphic symbols of spools

working
and indirect
positions

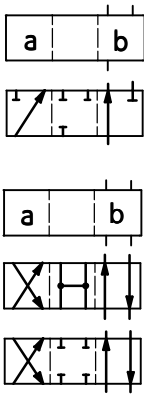

working
positions

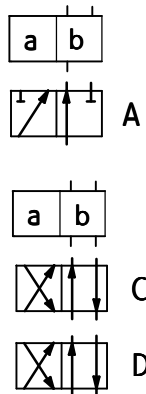

working
and indirect
positions

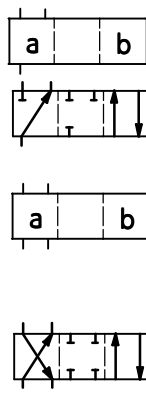

working
positions

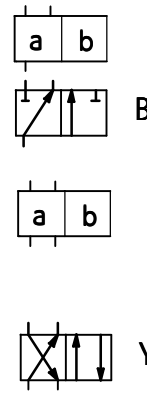

OVERALL AND CONNECTION DIMENSIONS

Directional spool valve - hand lever operated
type ...WMM10...-1X/...

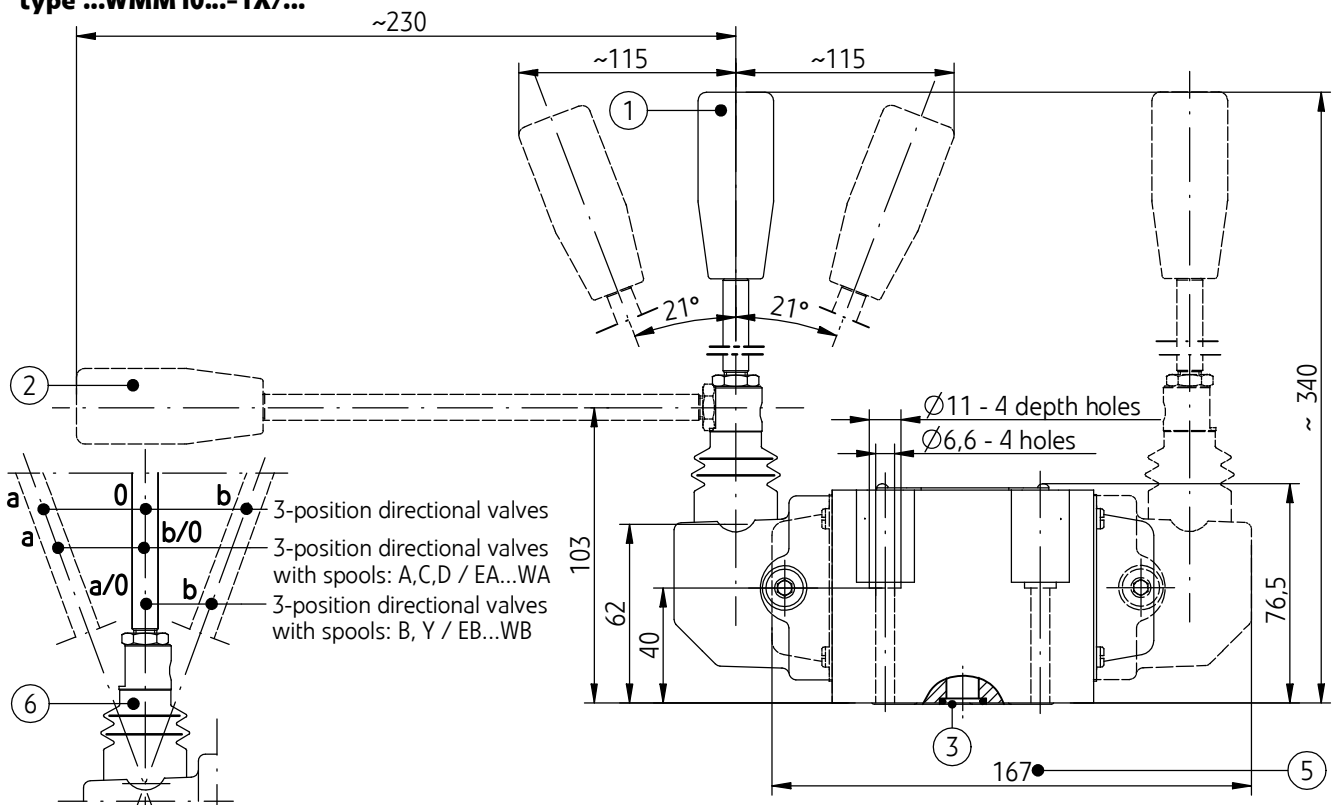

- 1 - Hand lever
- 2 - Hand lever (optionally mounted)
- 3 - Sealing ring o-ring 12 x 2 - 5 pcs/kit (P, T_A, T_B, A, B)
- 4 - Overall dimension of directional spool valve:
 - 3-position directional spool valve springs centered
 - 3-position directional spool valve positioned with detent (spool schemes: E, F, G, H, J, L, M, Q, R, T, U, V, W - page 4)
 - 2-position directional spool valve positioned with spring
 - 2-position directional spool valve positioned with detent (positions a, b - spool schemes: A, C, D - page 5)
 - positions a, 0 - spool schemes: EA, FA, GA, HA, JA, LA, MA, PA, QA, RA, TA, UA, VA, WA - page 4
 - positions 0, b - spool schemes: EB, FB, GB, HB, JB, LB, MB, PB, QB, RB, TB, UB, VB, WB - page 4)
- 5 - Overall dimension of directional spool valve:
 - 2-position directional spool valve positioned with spring
 - 2-position directional spool valve positioned with detent (positions a, b - spool schemes: B, Y - page 5)
- 6 - Positions of hand lever
- 7 - Porting pattern - configuration of connection holes in subplate in accordance with the following standards:
 - CETOP RP 121H - identified by CETOP 4.2-4-05-320 (nominal size CETOP 05)
 - ISO 4401 - identified by ISO 4401-05-04-0-94

(* - connection with 1 hole T from port side A or B is sufficient - holes T_A and T_B are connected to the port T in the housing of directional spool valve mounting bolts M6 x 50 -10.9 in accordance with PN -EN ISO 4762- 4 pcs/kit, tightening torque Md = 15 Nm
- 8 - Subplate surface required

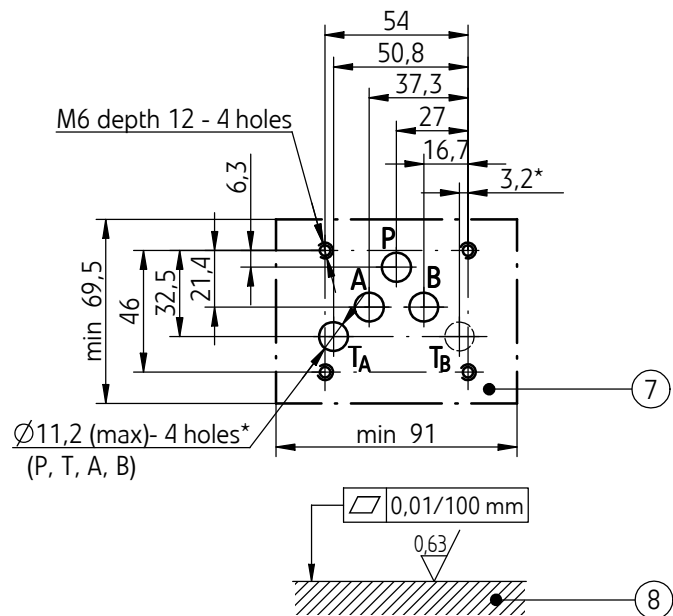
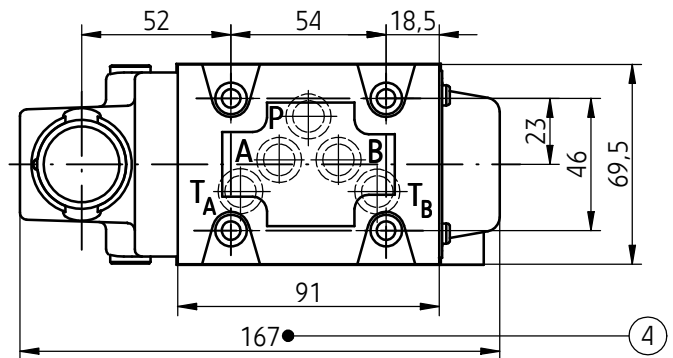

OVERALL AND CONNECTION DIMENSIONS

Directional spool valve - rotary knob operated type
 ...WMD10...-1X/...

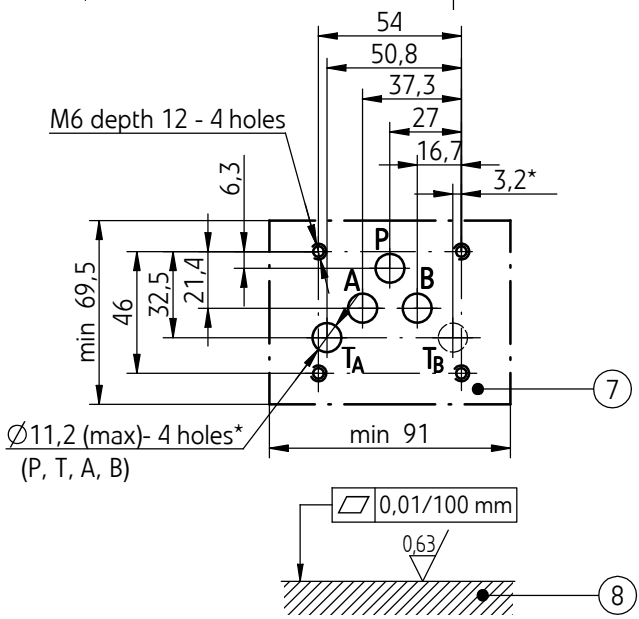
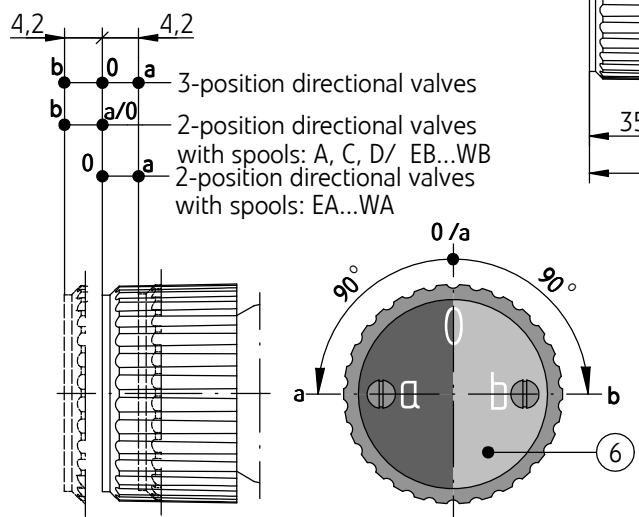
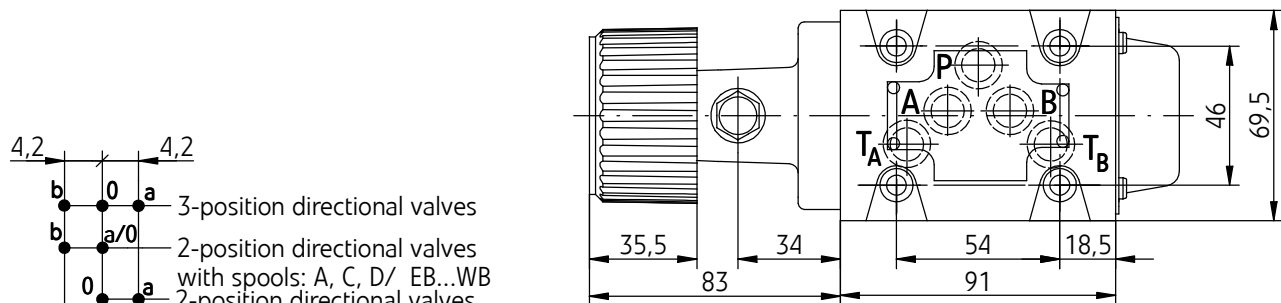
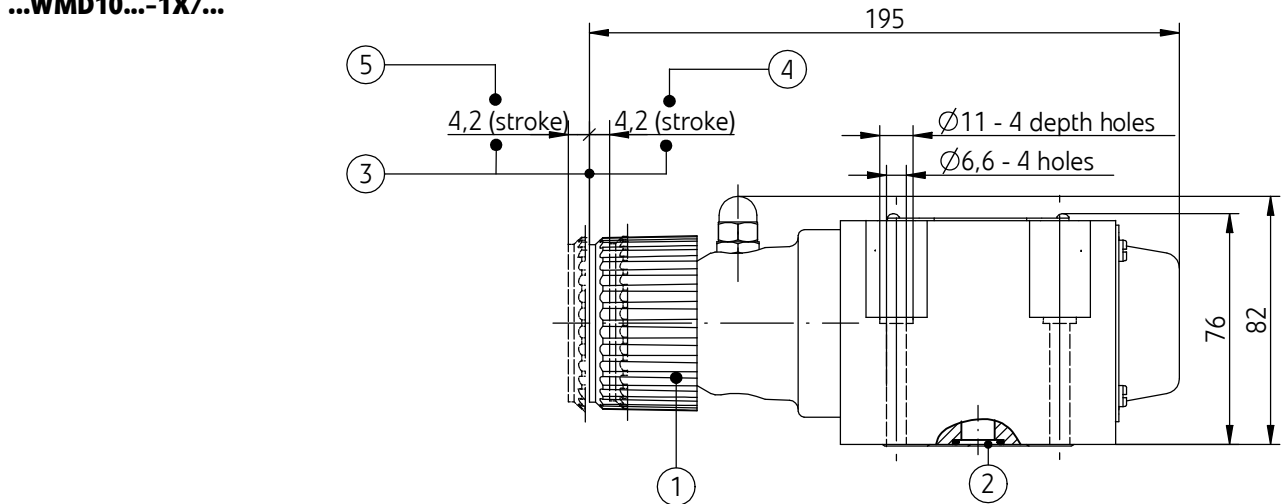

- 1 - Rotary knob
- 2 - Sealing ring **o-ring 12 x 2** - 5 pcs/kit (**P, T_A, T_B, A, B**)
- 3 - Stroke of rotary knob for **3-position** directional spool valve (spool schemes: **E, F, G, H, J, L, M, Q, R, T, U, V, W** - page 6)
- 4 - Stroke of rotary knob for **2-position** directional spool valve (positions **a, 0** - version WMD10...A... spool schemes: **EA, FA, GA, HA, JA, LA, MA, PA, QA, RA, TA, UA, VA, WA** - page 6)
- 5 - Stroke of rotary knob for **2-position** directional spool valve (positions **0, b** - version WMD10...B... spool schemes: **EB, FB, GB, HB, JB, LB, MB, PB, QB, RB, TB, UB, VB, WB** - page 6; positions **a, b** - spool schemes: **A, C, D** - page 5)
- 6 - Positions of rotary knob
- 7 - Porting pattern - configuration of connection holes in subplate in accordance with the following standards:
 - **CETOP RP 121H** - identified by **CETOP 4.2-4-05-320** (nominal size **CETOP 05**)
 - **ISO 4401** - identified by **ISO 4401-05-04-0-94**
- (*) - connection with 1 hole **T** from port side **A** or **B** is sufficient - holes **T_A** and **T_B** are connected to the port **T** in the housing of directional spool valve
- mounting bolts **M6 x 50 - 10.9** in accordance with **PN - EN ISO 4762** - 4 pcs/kit
- Tightening torque **Md = 15 Nm**
- 8 - Subplate surface required

OVERALL AND CONNECTION DIMENSIONS

**Directional spool valve - roller operated
type ... WMR10...-1X/...**

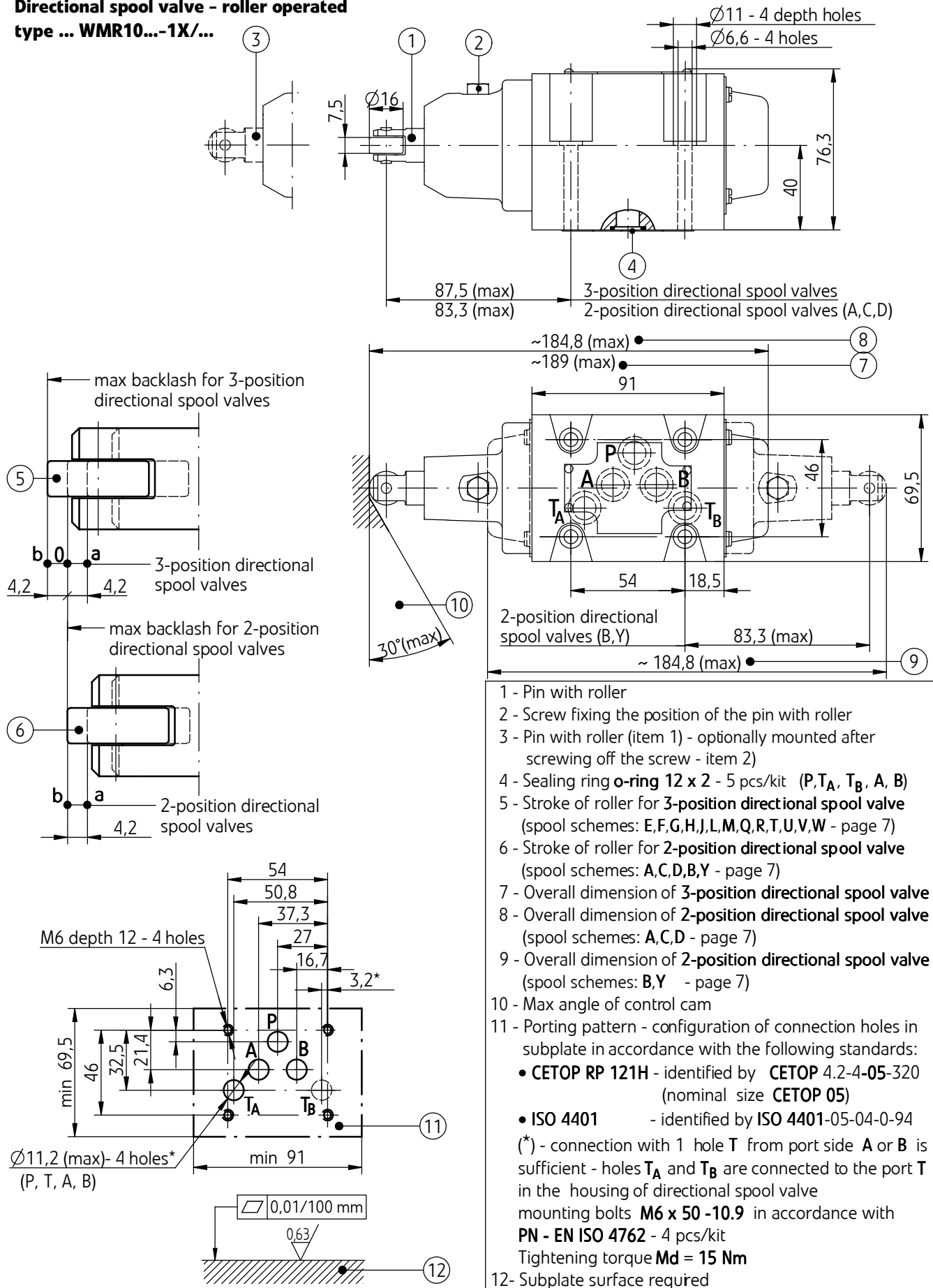

- 1 - Pin with roller
- 2 - Screw fixing the position of the pin with roller
- 3 - Pin with roller (item 1) - optionally mounted after screwing off the screw - item 2)
- 4 - Sealing ring o-ring 12 x 2 - 5 pcs/kit (P, T_A, T_B, A, B)
- 5 - Stroke of roller for 3-position directional spool valve (spool schemes: E, F, G, H, J, L, M, Q, R, T, U, V, W - page 7)
- 6 - Stroke of roller for 2-position directional spool valve (spool schemes: A, C, D, B, Y - page 7)
- 7 - Overall dimension of 3-position directional spool valve
- 8 - Overall dimension of 2-position directional spool valve (spool schemes: A, C, D - page 7)
- 9 - Overall dimension of 2-position directional spool valve (spool schemes: B, Y - page 7)
- 10 - Max angle of control cam
- 11 - Porting pattern - configuration of connection holes in subplate in accordance with the following standards:
 - CETOP RP 121H - identified by CETOP 4.2-4-05-320 (nominal size CETOP 05)
 - ISO 4401 - identified by ISO 4401-05-04-0-94
- (*) - connection with 1 hole T from port side A or B is sufficient - holes T_A and T_B are connected to the port T in the housing of directional spool valve
- mounting bolts M6 x 50 - 10.9 in accordance with PN - EN ISO 4762 - 4 pcs/kit
- Tightening torque Md = 15 Nm
- 12- Subplate surface required

OVERALL AND CONNECTION DIMENSIONS

Directional spool valve - hydraulically operated
type ...WH10...-1X/...

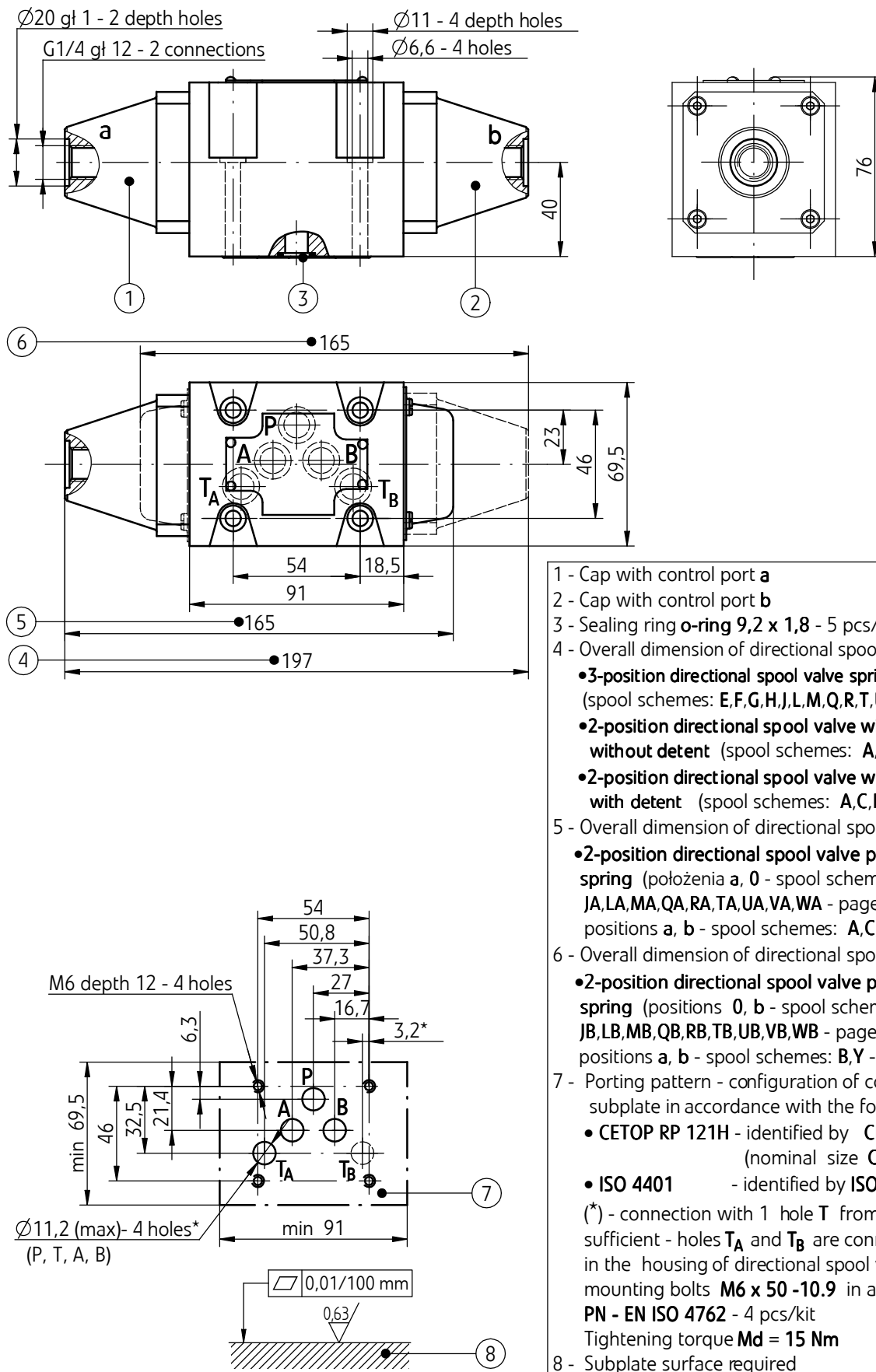

PERFORMANCE CURVES

measured at viscosity $\nu = 41 \text{ mm}^2/\text{s}$ and temperature $t = 50^\circ\text{C}$

Flow resistance curves

- type **WMM10...-12/...**, **WMM10...-12/F...**
- type **WMD10...-12/F...**
- type **WMR10...-12...**
- type **WH10...-12.../...**, **WH10...-12/O...**, **WH10...-12/OF...**

Characteristic curves $\Delta p(Q)$ for directional spool valves with various spool types

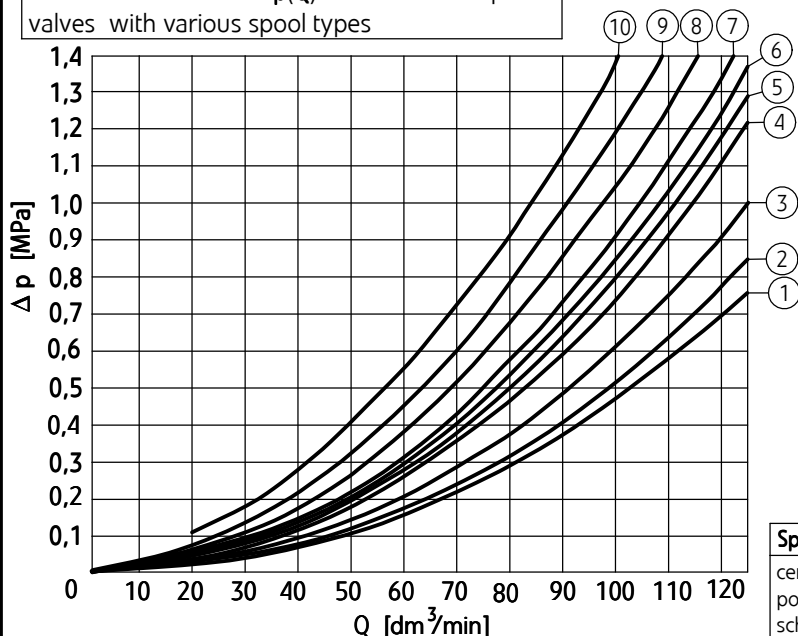

Spool type	Characteristic curve number					
	flow direction					
end position - b scheme - page 3	P → A	P → B	P → T	A → T	B → T	B → A
R	-	-	-	-	-	9

Spool type schemes page - 3, 4	Charakteristic curve number			
	flow direction			
	P → A	P → B	A → T	B → T
A, B	3	3	-	-
C	3	3	4	5
D, Y	5	5	6	6
E	1	1	4	4
F	2	3	7	4
G	3	3	6	7
H	1	1	6	7
J	1	1	3	3
L	2	2	3	5
M	1	1	4	5
P	4	2	5	7
Q	1	2	1	3
R	3	6	4	-
T	3	3	6	7
U, V	2	2	3	3
W	2	2	4	5

Spool type central position - 0 schemes-page3	Charakteristic curve number					
	flow direction					
	P → A	P → B	P → T	A → T	B → T	B → A
F	4	-	9	9	-	-
P	-	5	10	-	8	-
G, T	-	-	9	-	-	-
H	-	-	3	-	-	-

Flow limits curves

- type **WMM10...-12/...**, **WMM10...-12/F...**
- type **WMD10...-12/F...**
- type **WMR10...-12...**
- type **WH10...-12.../...**, **WH10...-12/O...**, **WH10...-12/OF...**

Characteristic curves $p-Q$ for directional spool valves with various spools

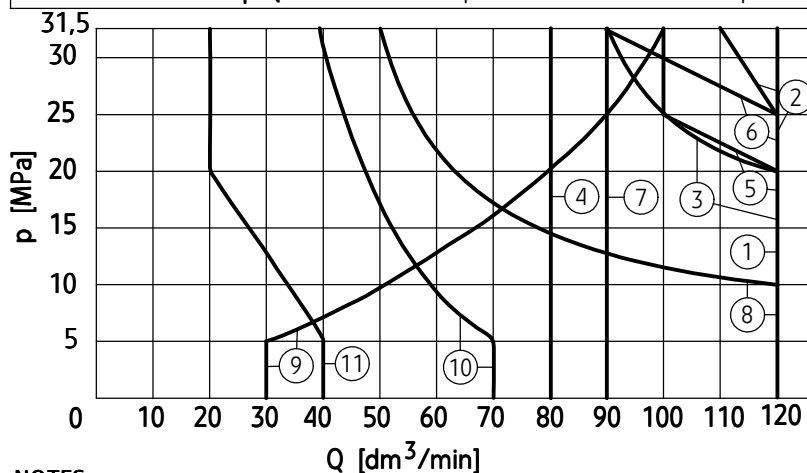

NOTES:

Above flow limits are related to symmetrical flow through all ports i.e. if the oil flows from port **P** to port **A**, then the same flow rate is from port **B** to port **T** (applied to directional control valves with 4 service

ports). Degree of asymmetry affects adversely the parameters.

(*) - non applicable for valves type **WMD10...; WMR10...**

(**) - applicable only for valves type **WH10...**

Spool type schemes - page 4 - 9	Charakteristic curve number
C, (C/O, C/OF)**	1
D, (D/O, D/OF)**, Y*	
M	
E	2
J	3
H, Q, W	4
R	5
L	6
U	7
A, A/O, A/OF, B*	8
V	9
F, P, G	10
T	11

HOW TO ORDER

		10	+	/				*
--	--	-----------	---	---	--	--	--	---

Number of service ports

3-way - for spools A, B = **3**
4-way - the other spools = **4**

Type of operation

hand lever operated = **WMM**
 rotary knob operated = **WMD**
 roller operated = **WMR**
 hydraulically operated = **WH**

Nominal size (NS)

NS10 = **10**

Spool type

spool schemes for directional spool valve:

type **WMM** - according to page **4, 5**
 type **WMD** - according to page **5, 6**
 type **WMR** - according to page **7**
 type **WH** - according to page **8, 9**

Series number

(10-19) - connection and installation dimensions unchanged = 1X
series 12 = **12**

Spool positioning

spring centering - available to
 directional spool valves type: **WMM, WMR, WH** = **no designation**
 with detent - available to
 directional spool valves type: WMM, WMD = F
 without return springs, without detent - available only to
 directional spool valves type WH = 0
 without return springs, with detent - available only to
 directional spool valves type WH = OF

Throttle insert (in port P)

without throttle insert = **no designation**
 throttle insert ϕ 0,8 = B 08
 throttle insert ϕ 1,0 = B 10
 throttle insert ϕ 1,2 = B 12

Sealing

NBR (for fluids on mineral oil base) = **no designation**
 FPM (for fluids on phosphate ester base) = V

Further requirements in clear text (to be agreed with the manufacturer)

NOTES:

Directional spool valve should be ordered according to the above coding.

The symbols in bold are preferred versions in short delivery time.

Coding examples: 4WMM10 J -12/B08; 4WMD10E -12/F B08; 4WMR10E -12/B08;
 4WH10 J -12/B08

SUBPLATES AND MOUNTING BOLTS

Subplates must be ordered according to the data sheet

WK 496 520. Subplates:

G 66/01 - threaded connection G 3/8

G 67/01 - threaded connection G 1/2

G 89/01 - threaded connection G1/4

G 67/02 - threaded connection M22 x1,5

Subplates and bolts fixing directional valve M6 x 50 - 10,9 in accordance with PN-EN ISO 4762 - 4 pcs/kit must be ordered separately.

Tightening torque for bolts Md = 15 Nm

EXAMPLES OF APPLICATION IN HYDRAULIC SYSTEM

Directional spool valve - hand lever operated type WMM10

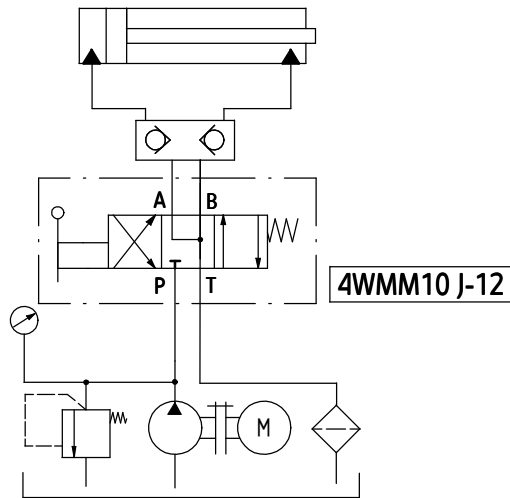

Directional spool valve - hydraulically operated type WH10

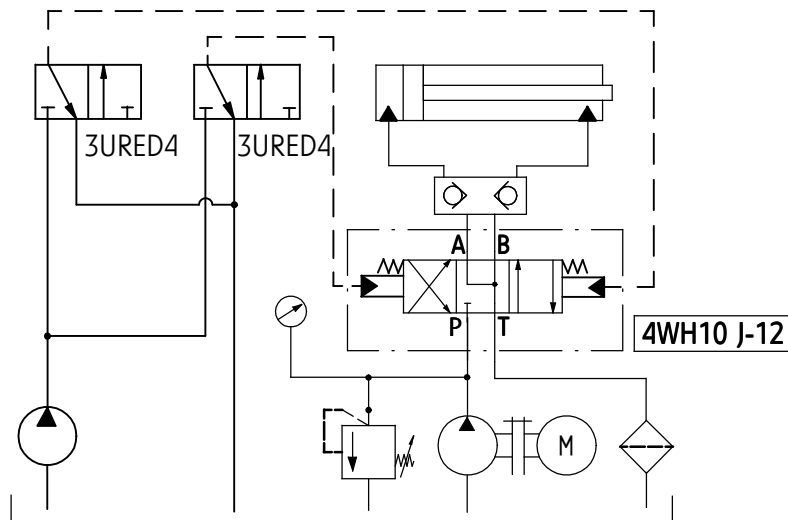

PONAR Wadowice S.A.
ul. Wojska Polskiego 29
34-100 Wadowice
tel. +48 33 488 29 00
fax. +48 33 488 21 03
www.ponar-wadowice.pl

PONAR[®]
wadowice