

SD 25

SECTIONAL
DIRECTIONAL CONTROL VALVES



Features

Simple, compact and heavy duty designed sectional valve from 1 to 12 sections for open and closed centre hydraulic systems.

- Fitted with a main pressure relief valve and a load check valve on every working section
- Available with parallel or series circuit.
- Optional carry-over port.
- A wide variety of service ports and circuit valves.
- Available manual, pneumatic, hydraulic, electro-hydraulic, and remote with flexible cables spool control kits.
- Diameter 25 mm (0.98 in) interchangeable spools.

Working conditions

This catalogue shows technical specifications and diagrams measured with mineral oil of 46 mm²/s - 46 cSt viscosity at 40°C temperature.

Nominal flow rating		240 l/min	
Operating pressure (maximum)	<i>parallel circuit</i>	315 bar	4600 psi
	<i>series circuit</i>	210 bar	3050 psi
Back pressure (maximum)	<i>on outlet port T</i>	25 bar	360 psi
Internal leakage A(B)→T	<i>Δp=100 bar - 1450 psi fluid and valve at 40°C</i>	4 cm ³ /min	0.24 in ³ /min
Fluid		Mineral base oil	
Fluid temperature	<i>with NBR (BUNA-N) seals</i>	from -20° to 80°C	
	<i>with FPM (VITON) seals</i>	from -20° to 100°C	
Viscosity	<i>operating range</i>	from 15 to 75 mm ² /s	<i>from 15 to 75 cSt</i>
	<i>min.</i>	12 mm ² /s	12 cSt
	<i>max.</i>	400 mm ² /s	400 cSt
Max level of contamination		19/16 - ISO 4406	
Ambient temperature		from -40° to 60°C	

NOTE - For different conditions please contact Sales Dept.

Additional information

This catalogue shows the product in the most standard configurations.
Please contact Sales Dpt. for more detailed information or special request.

WARNING!

All specifications of this catalogue refer to the standard product at this date.
Walvoil, oriented to a continuous improvement, reserves the right to discontinue, modify or revise the specifications, without notice.

WALVOIL IS NOT RESPONSIBLE FOR ANY DAMAGE CAUSED BY AN
INCORRECT USE OF THE PRODUCT.

5th edition September 2003:

This edition supersedes all prior documents.

Dimensional data (parallel circuit)

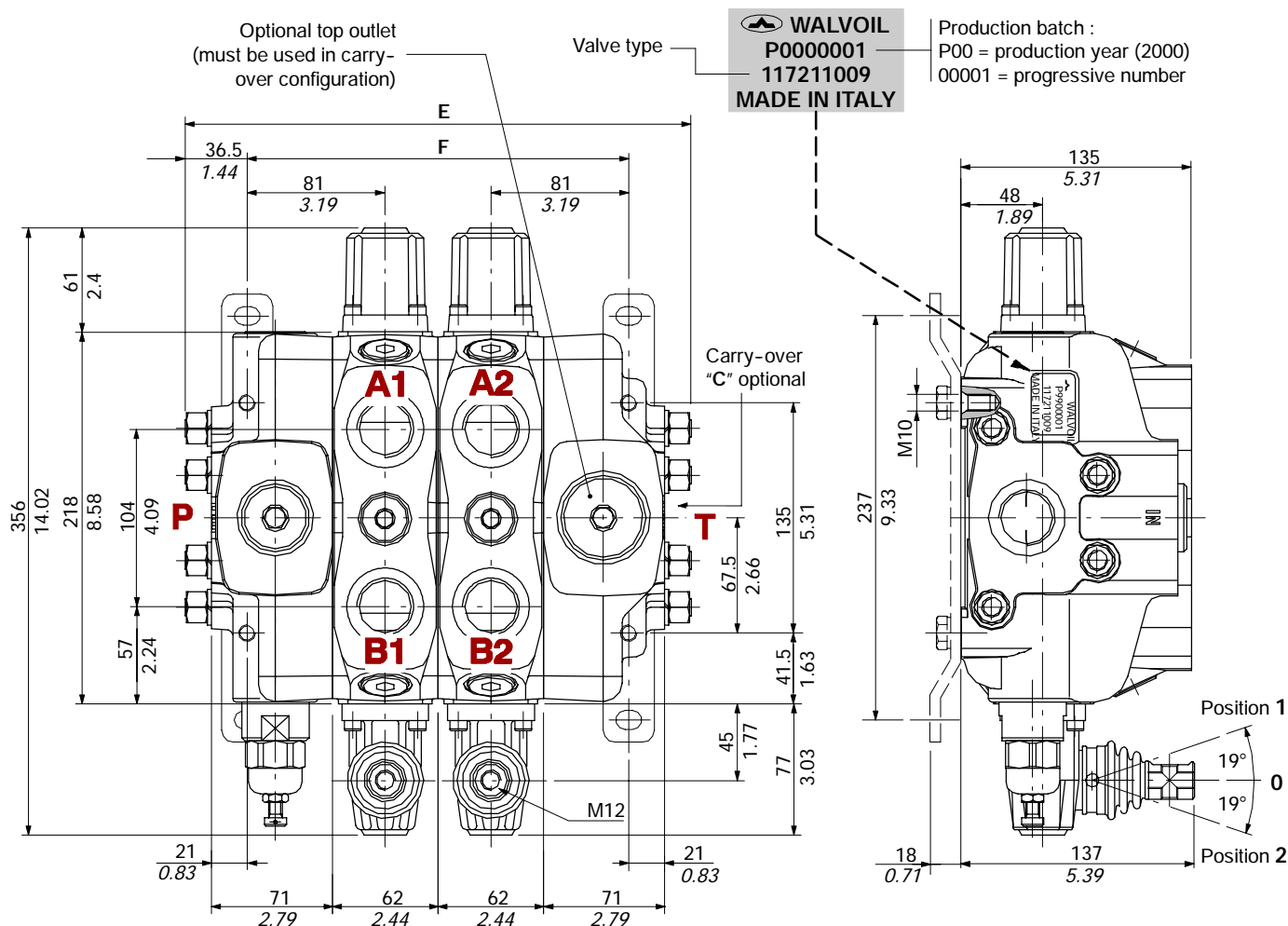

TYPE	E		F		Weight	
	mm	in	mm	in	kg	lb
SD25/1	235	9.25	162	6.38	37.6	83
SD25/2	297	11.69	224	8.82	48.6	107
SD25/3	359	14.13	286	11.26	59.6	131.4
SD25/4	421	16.57	348	13.7	70.6	155.6
SD25/5	483	19.02	410	16.14	81.6	180
SD25/6	545	21.46	472	18.58	92.6	204

TYPE	E		F		Weight	
	mm	in	mm	in	kg	lb
SD25/7	607	23.9	534	21.02	103.6	228.2
SD25/8	669	26.34	596	23.46	114.6	252.4
SD25/9	731	28.78	658	25.9	125.6	276.6
SD25/10	793	31.22	720	28.34	136.6	300.8
SD25/11	855	33.66	782	30.78	147.6	325
SD25/12	917	36.1	844	33.22	158.6	349.2

Standard threads

PORTS	BSP (ISO 228/1)	UN-UNF (ISO 11926-1)
Inlet P	G 1	1 5/8-12 UN-2B (SAE 20)
A and B ports	G 1	1 5/16-12 UN-2B (SAE 16)
Outlet T and carry-over C	G 1 1/4	1 5/8-12 UN-2B (SAE 20)
PILOT PORTS		
Hydraulic	G 1/4	9/16-18 UNF-2B (SAE 6)
Pneumatic	NPTF 1/8-27	NPTF 1/8-27

Performance data (pressure drop vs. flow)

Open centre

From side inlet to side outlet.

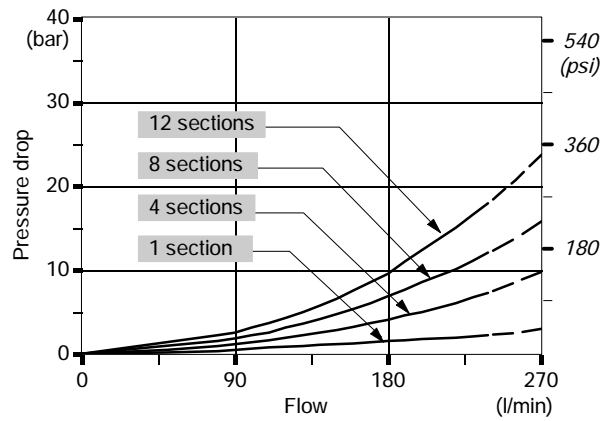
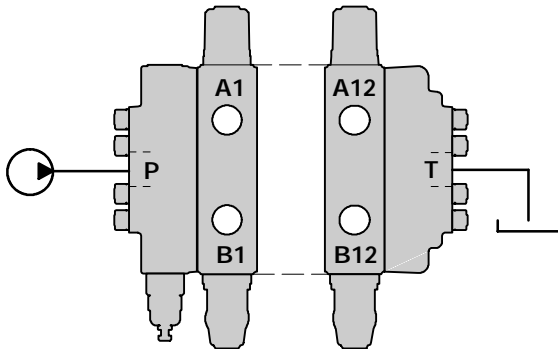

Inlet to work port

From side inlet to A port (spool in position 1) or B port (spool in position 2).

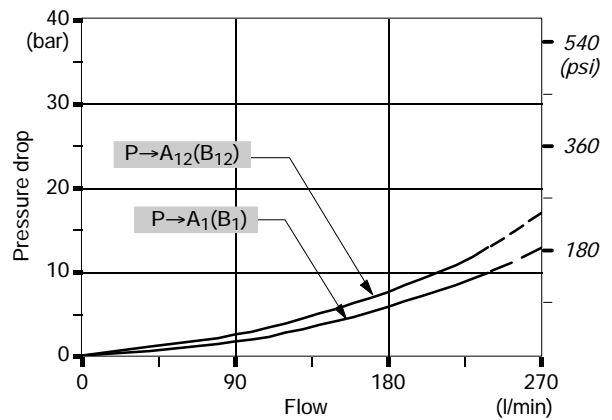
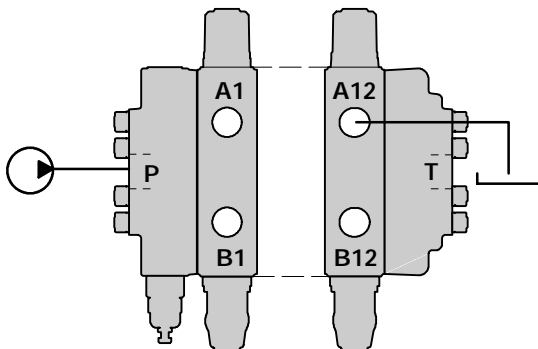

Work port to outlet

From A port (spool in position 2) or B port (spool in position 1) to side outlet.

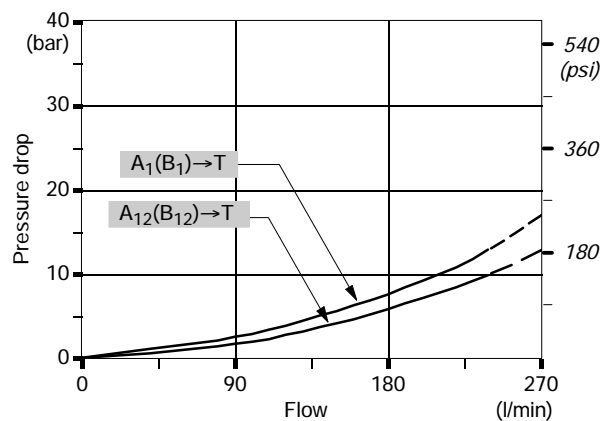
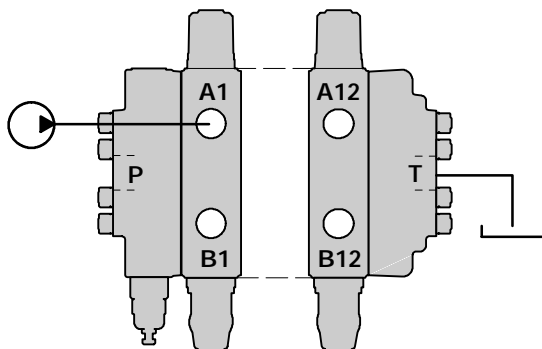

NOTE - Measured with spool type 1.

2 parallel working sections

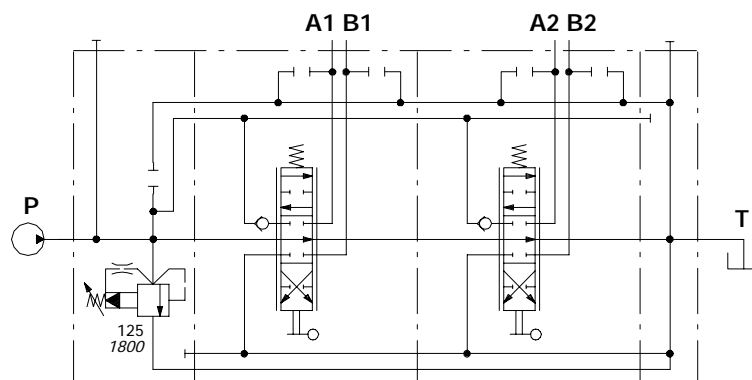
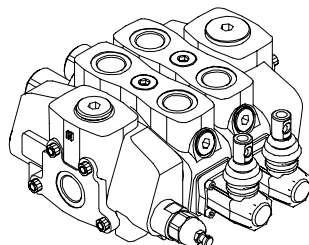

Ex.: SD25/2/AC(XG-125)/18L/18L/RC

Intermediate pressure compensated flow divider section

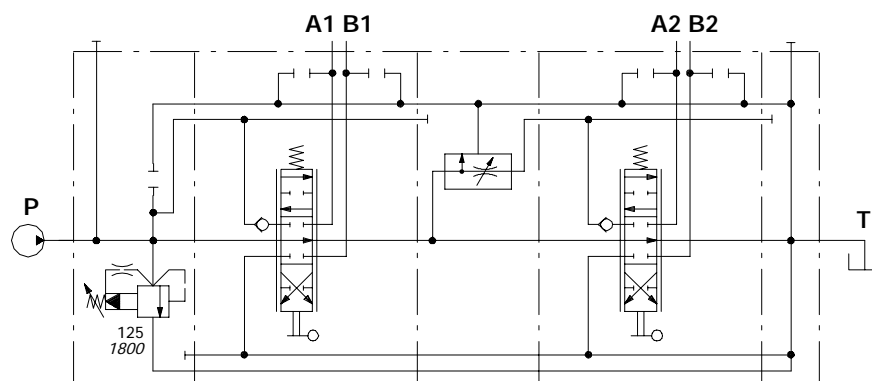
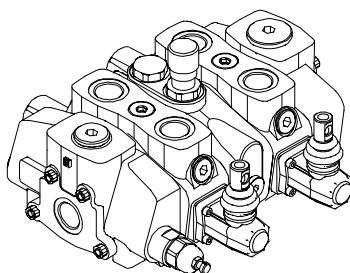

Ex.: SD25/2/AC(XG-125)/18L/DFG/18L/RC

2 inlet cover and mid return manifold section

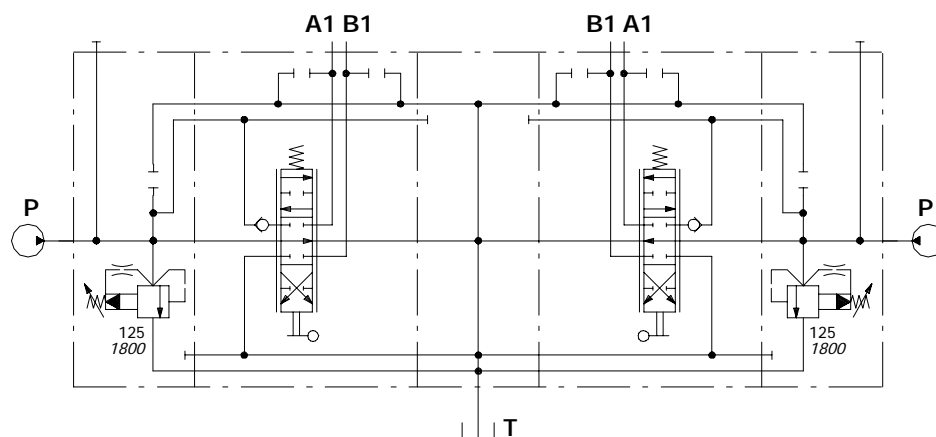
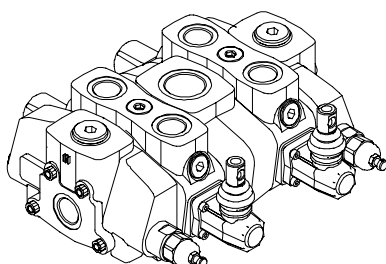

Ex.: SD25/2/AC(XG-125)/18L/CS1/18L/BC(XG-125)

Hydraulic circuit

Inlet cover

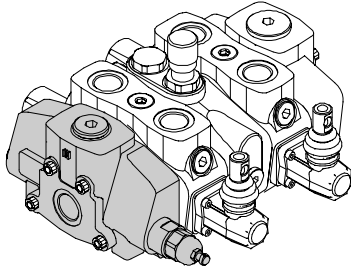

TYPE	CODE	DESCRIPTION
AC(YG3)	617201101	Side inlet with direct pressure relief valve
AD(YG3)	617201102	Top inlet with direct pressure relief valve
AC(XG)	617201112	Side inlet with pilot operated pressure relief valve
AC(SV)	617201109	Side inlet with relief valve blanking plug

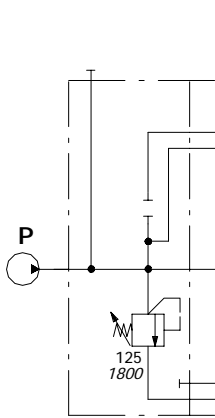

AC(YG3-125)

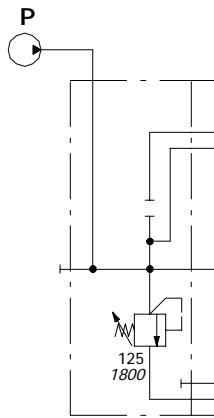

AD(YG3-125)

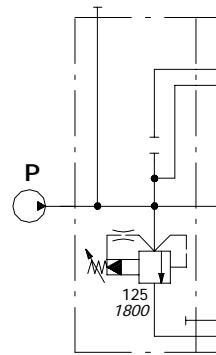

AC(XG-125)

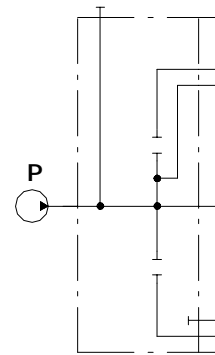

AC(SV)

Working sections

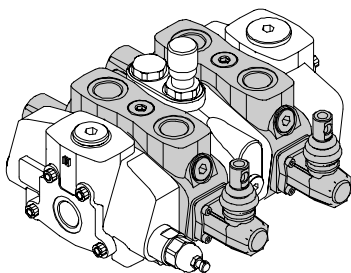

TYPE	CODE	DESCRIPTION
P-18L	617101001	Parallel
S-18L	617111001	Series

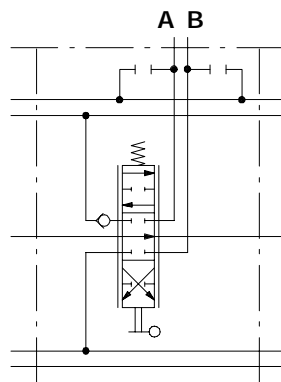

P-18L

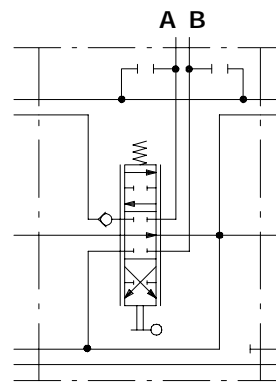

S-18L

Intermediate sections

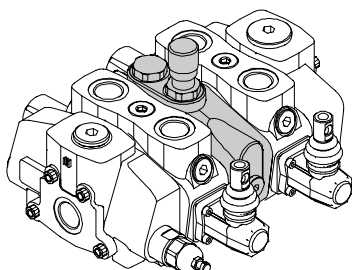

TYPE	CODE	DESCRIPTION
CS1	617401010	Mid return manifold section
DFG	617411020	Pressure compensated flow divider section
EI1(XG)	617421010	Secondary pilot operated pressure relief valve
EI2(XG)	617421015	Mid inlet with secondary pilot operated pressure relief valve

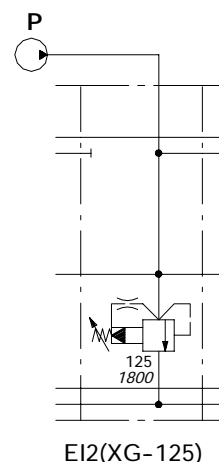
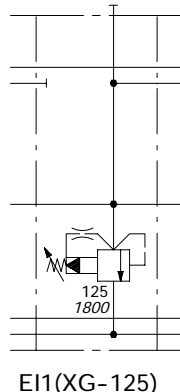
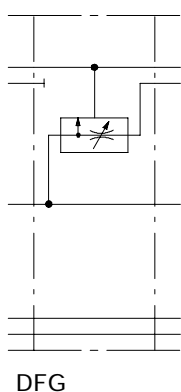
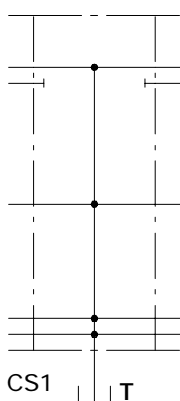

Outlet cover

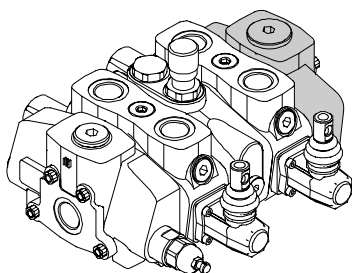

TYPE	CODE	DESCRIPTION
RC	617300110	Side outlet
RD	617300120	Top outlet
RE	617300111	Top outlet with carry-over
RK	617300112	Top outlet with closed centre

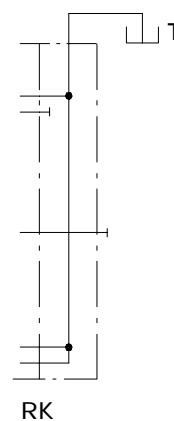
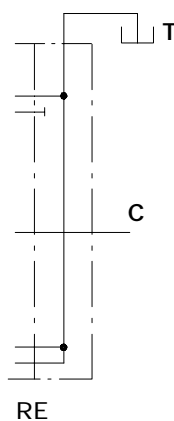
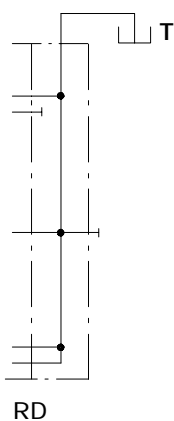
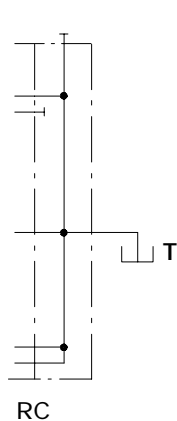

NOTE - Codes are referred to **BSP** thread.

Assembling parts

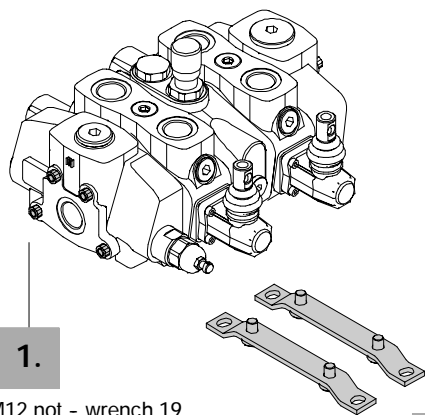

PART	CODE	DESCRIPTION
1.	5TIR112234	Tie rod kit for 1 section valve
	5TIR112296	Tie rod kit for 2 sections valve
	5TIR112358	Tie rod kit for 3 sections valve
	5TIR112420	Tie rod kit for 4 sections valve
	5TIR112482	Tie rod kit for 5 sections valve
	5TIR112544	Tie rod kit for 6 sections valve
	5TIR112606	Tie rod kit for 7 sections valve
	5TIR112668	Tie rod kit for 8 sections valve
	5TIR112730	Tie rod kit for 9 sections valve
	5TIR112792	Tie rod kit for 10 sections valve
	5TIR112854	Tie rod kit for 11 sections valve
	5TIR112916	Tie rod kit for 12 sections valve

Tie rod tightening torque 50 Nm (36.88 lbf^t)

2.	5STA130270	Brakets kit
----	------------	-------------

Description example:

FE SD25 / A C (XG - 125) EL-12VDC *

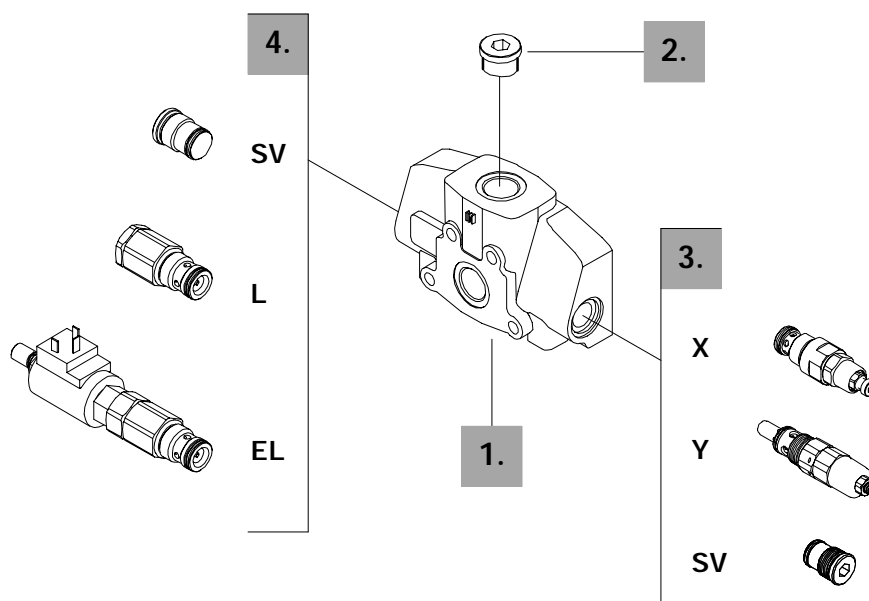
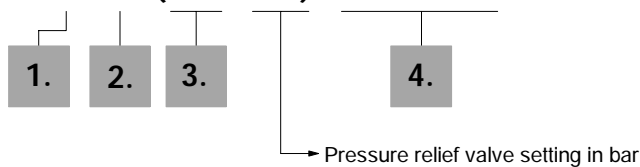
**1. Inlet cover body ***

CODE	DESCRIPTION
5FIA125300	AC-AD type body

2. Inlet port selection *

CODE	DESCRIPTION
3XTAP740210	G 1 plug (n.1 plug required)

3. Inlet relief options

TYPE	CODE	DESCRIPTION
<u>VMP25/1 pilot operated pressure relief valve type X (standard)</u>		
(XG-125)	X008211120	Range 25 to 315 bar / 360 to 4600 psi standard setting 125 bar / 1800 psi
<u>VMD25/1 direct pressure relief valve type Y</u>		
(YG3-125)	XCAR125213	Range 125 to 220 bar / 1800 to 2900 psi standard setting 125 bar / 1800 psi
Standard setting is referred to 10 l/min flow.		

SV	3XTAP536540	Relief valve blanking plug
----	-------------	----------------------------

4. Inlet valves options

TYPE	CODE	DESCRIPTION
L	5CAR425300	Hydraulic pilot unloader valve (FC1.5)
EL	YCAR425305	12 VDC electromagnetic controlled unloader valve
	YCAR425310	24 VDC electromagnetic controlled unloader valve
SV	3XTAP536540	Relief valve blanking plug

NOTE (*) - Items are referred to **BSP** thread.

Working section options

Description example:

EL SD25 / P - 1 8 L . P 1 (G3 - 100) *

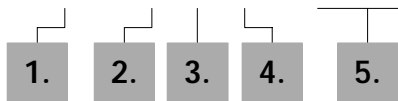

- 1 mounted on A port.
- 2 mounted on B port.
- 3 mounted on A and B ports.

→ Port relief valve setting in bar

1. Working section kits *

TYPE	CODE	DESCRIPTION
P	5EL1253000	Parallel
S	5EL2253000	Series

Include boby, seals, rings and load check valve.

2. Spool options

TYPE	CODE	CIRCUIT DESCRIPTION
1	3CU2710100	Double acting, 3 positions, with A and B closed in neutral position
1A	3CU2721100	Double acting, 3 positions, with A open to tank in neutral position
2	3CU2725100	Double acting, 3 positions, with A and B open to tank in neutral position
3	3CU2731100	Single acting on A, 3 positions, B plugged; requires G1 plug (see part I)
4	3CU2735100	Single acting on B, 3 positions, A plugged; requires G1 plug (see part I)

3. "A" side spool positioners

TYPE	CODE	DESCRIPTION
8	5V08120000	With spring return in neutral position
9B	5V09120000	With detent in position 1 and spring return in neutral position
10B	5V09120000	With detent in position 2 and spring return in neutral position
11	5V11120000	With detent in position 1, neutral and 2
11B	5V11220000	With detent in position 1 and 2, spring return in neutral position
8P	5V08120701	Pneumatic kit
8EI3	5V08120350	12 VDC ON/OFF electro-hydraulic kit
	5V08120351	24 VDC ON/OFF electro-hydraulic kit

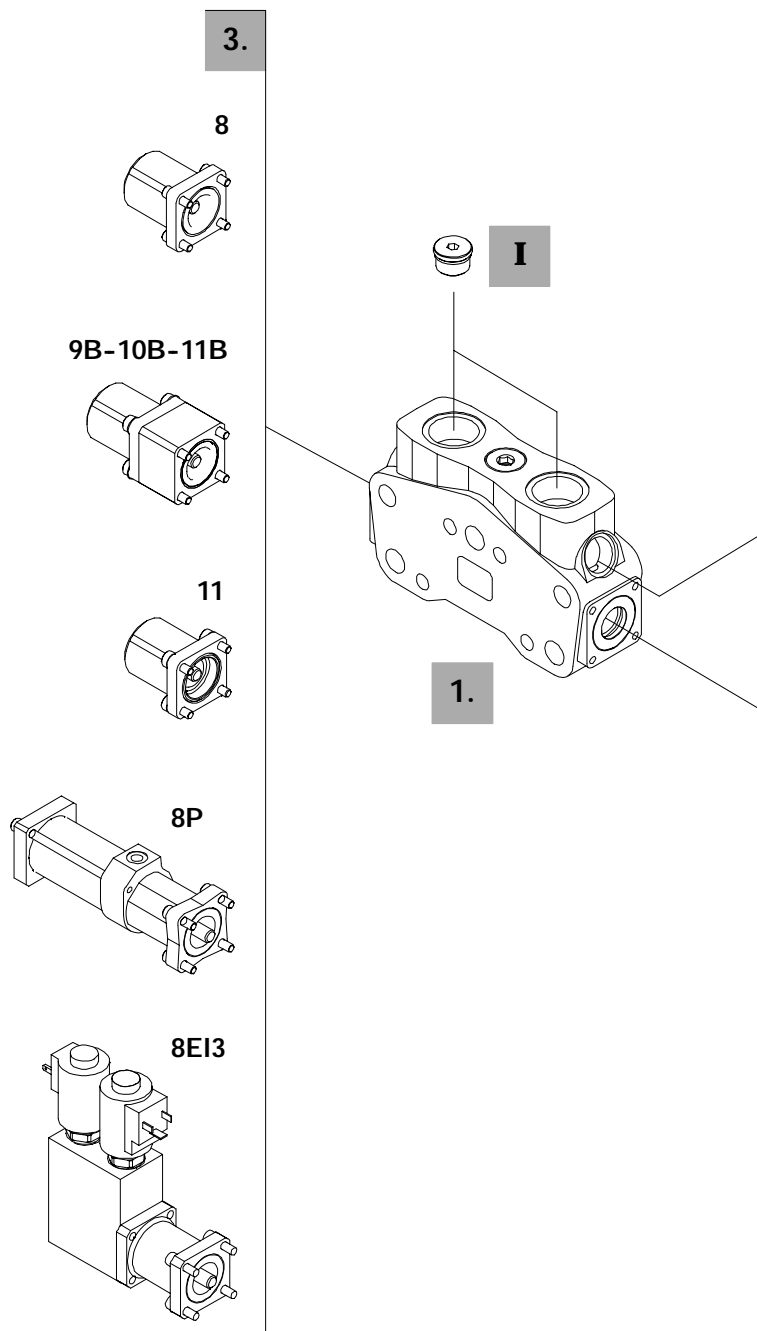

NOTE (*) - Items are referred to **BSP** thread.

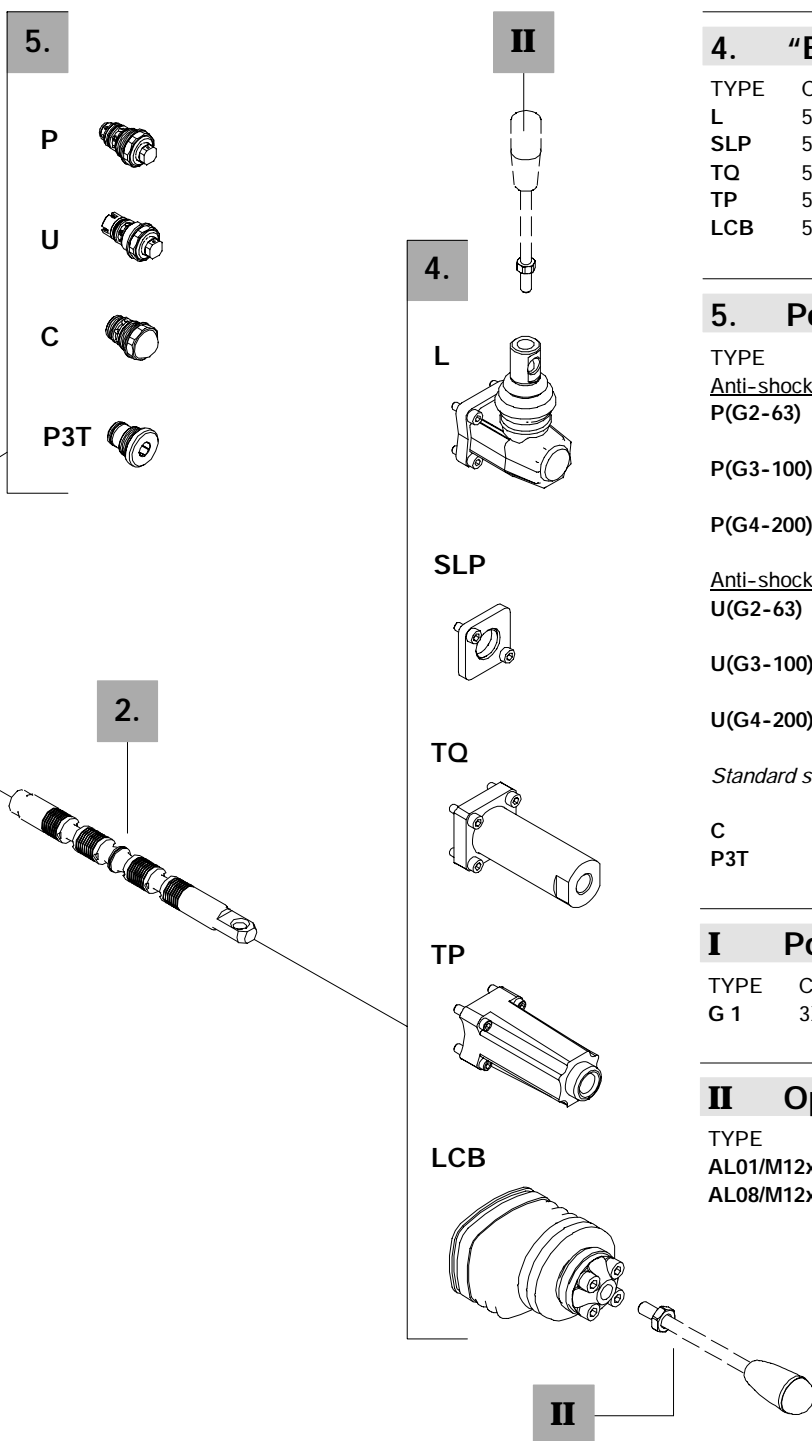

4. "B" side options

TYPE	CODE	DESCRIPTION
L	5LEV120000	Standard lever
SLP	5COP120000	Without lever, with dust proof plate
TQ	5TEL120100	CD cable connection
TP	5TEL120005	CG cable connection
LCB	5CLO225000	Mechanical joystick

5. Port relief options

TYPE	CODE	DESCRIPTION
<u>Anti-shock valve</u>		
P(G2-63)	XCAR216115	Range 63 to 125 bar / from 900 to 1800 psi standard setting 63 bar / 900 psi
P(G3-100)	XCAR216116	Range 100 to 250 bar / from 1450 to 3600 psi standard setting 100 bar / 1450 psi
P(G4-200)	XCAR216117	Range 200 to 315 bar / from 2900 to 4600 psi standard setting 200 bar / 290 psi
<u>Anti-shock and anti-cavitation valve</u>		
U(G2-63)	XCAR316112	Range 63 to 125 bar / from 900 to 1800 psi standard setting 63 bar / 900 psi
U(G3-100)	XCAR316113	Range 100 to 250 bar / from 1450 to 3600 psi standard setting 100 bar / 1450 psi
U(G4-200)	XCAR316114	Range 200 to 315 bar / from 2900 to 4600 psi standard setting 200 bar / 290 psi
Standard setting is referred to 10 l/min flow.		
C	3XCAR416100	Anti-cavitation
P3T	3XTAP528360	A and B ports valve blanking plugs

I Port plug *

TYPE	CODE	DESCRIPTION
G 1	3XTAP740210	Plug for single acting spool

II Optional hand levers

TYPE	CODE	DESCRIPTION
AL01/M12x200	170013020	For L lever box L= 200mm/ 7.87in
AL08/M12x250	170013125	For LCB joystick L= 250mm/ 9.84in

For special configurations see pages 13 and 14

Spools options

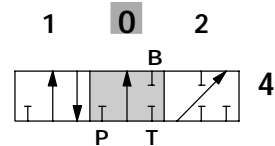
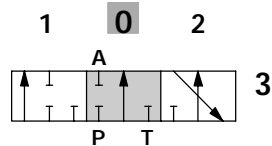
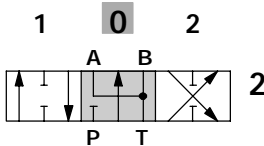
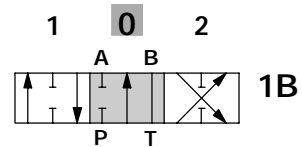
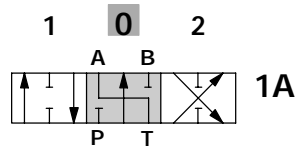
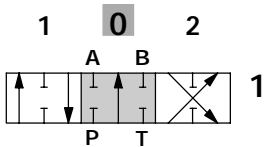

"B" port plugged

"A" port plugged

"A" side spool positioners

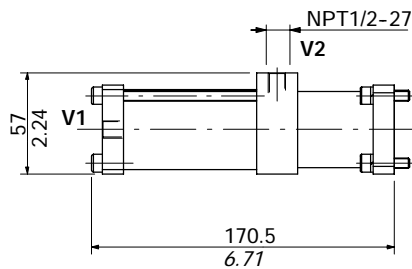
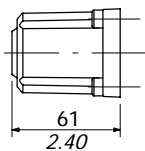

Operating features

Pilot pressure : min 6 max 10 bar
min 87 max 145 psi

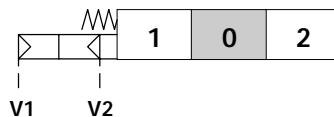
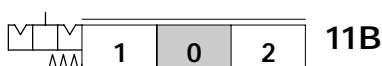
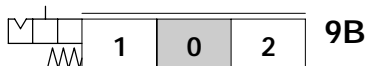
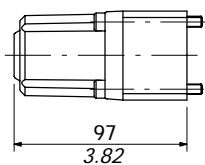
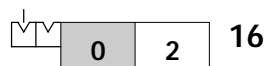
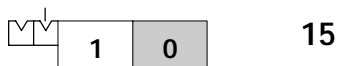
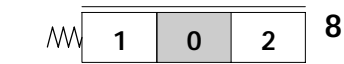

8P

ON/OFF pneumatic kit

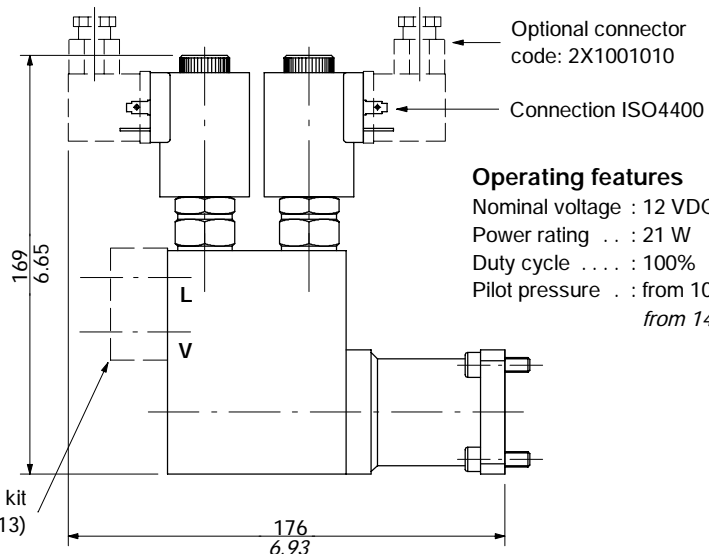

Operating features

Nominal voltage : 12 VDC / 24 VDC
Power rating . . . : 21 W
Duty cycle : 100%
Pilot pressure . . : from 10 to 50 bar
from 145 to 725 psi

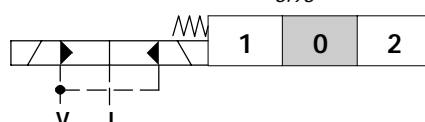

8E13

ON/OFF electro-hydraulic kit

Electro-hydraulic feeder kit

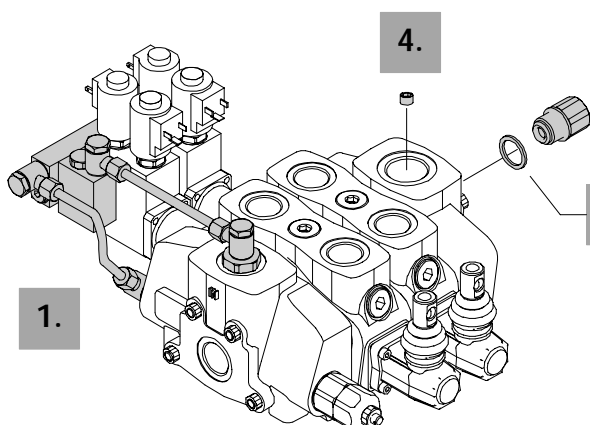

PART	TYPE	CODE	DESCRIPTION
1.	KE1R3	5KE1R31730	kit for 1 section
	KE2R3	5KE2R31730	kit for 2 sections
	KE3R3	5KE3R31730	kit for 3 sections
	KE4R3	5KE4R31730	kit for 4 sections
	KE5R3	5KE5R31730	kit for 5 sections
	KE6R3	5KE6R31730	kit for 6 sections
2.	VRE	3XGIU650740	G 1-1/4 back-pressure valve (carry-over configuration)
3.		4RON442934	G 1-1/4 washer
4.	RE	4TAP426612	G 3/4 plug

NOTE - Codes are referred to **BSP** thread.

Special configurations

Hydraulic spool control

Operating features

Adjustment range : from 5.8 to 19 bar / 84 to 276 psi - diagram 024

Max.pilot pressure : 100 bar / 1450 psi

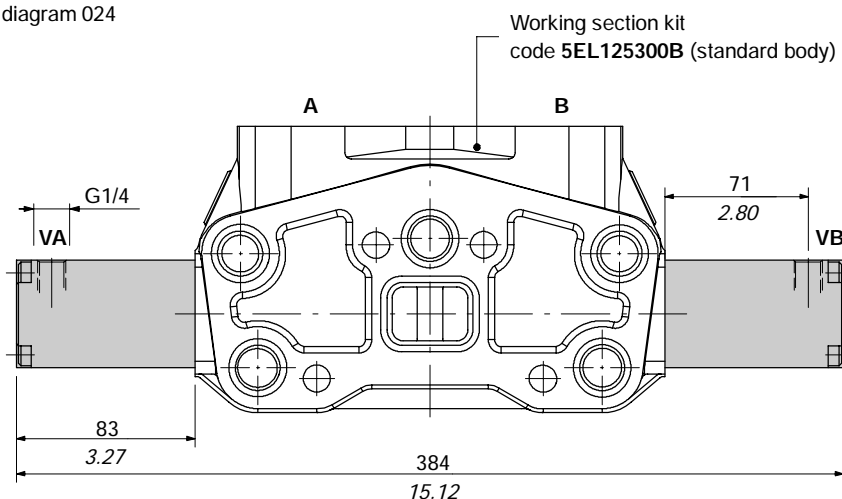
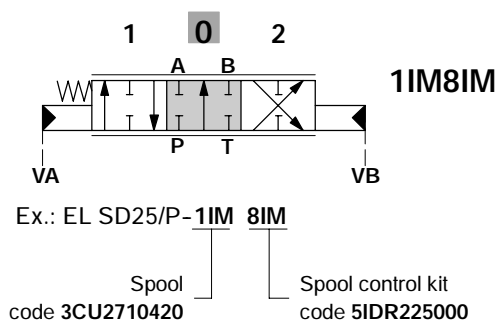

Special configuration

4th position floating circuit

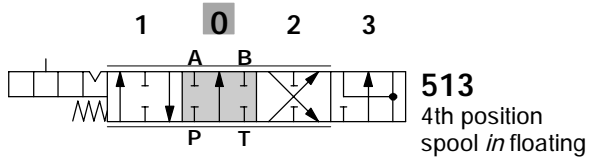

513
4th position
spool *in floating*

Ex.: EL SD25/P-5 13...

Spool
code 3CU2741100

Spool control kit
code 5V13025000

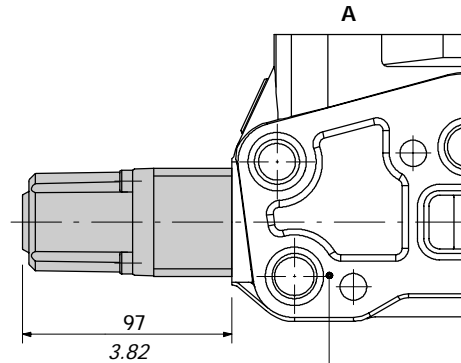

Working section kit
code 5EL1253200 (special body)

Regenerative circuit

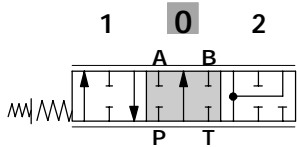

8P8CR
Spool *in regenerative*

Ex.: EL SD25/P-8P 8CR...

Spool
code 3CU2761100

Spool control kit
code 5V08120020

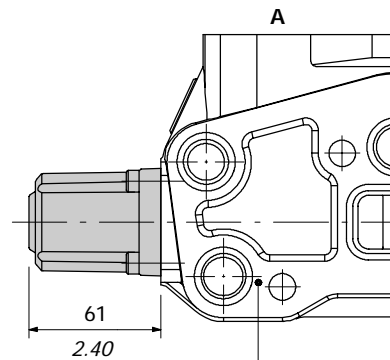

Working section kit
code 5EL1253400 (special body)

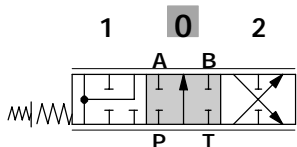

8F8CR
Spool *out regenerative*

Ex.: EL SD25/P-8F 8CR...

Spool
code 3CU2761200

Spool control kit
code 5V08120020

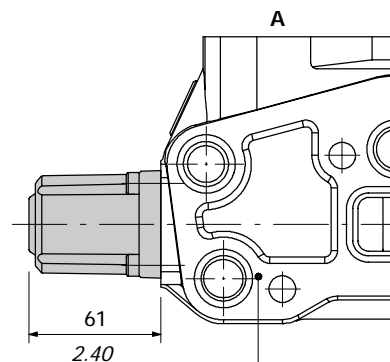

Working section kit
code 5EL1253000 (standard body)

CS3

Mid return manifold.

To assemble different sizes of valve. Tie rods are special. Available combination SD25 / SD16.

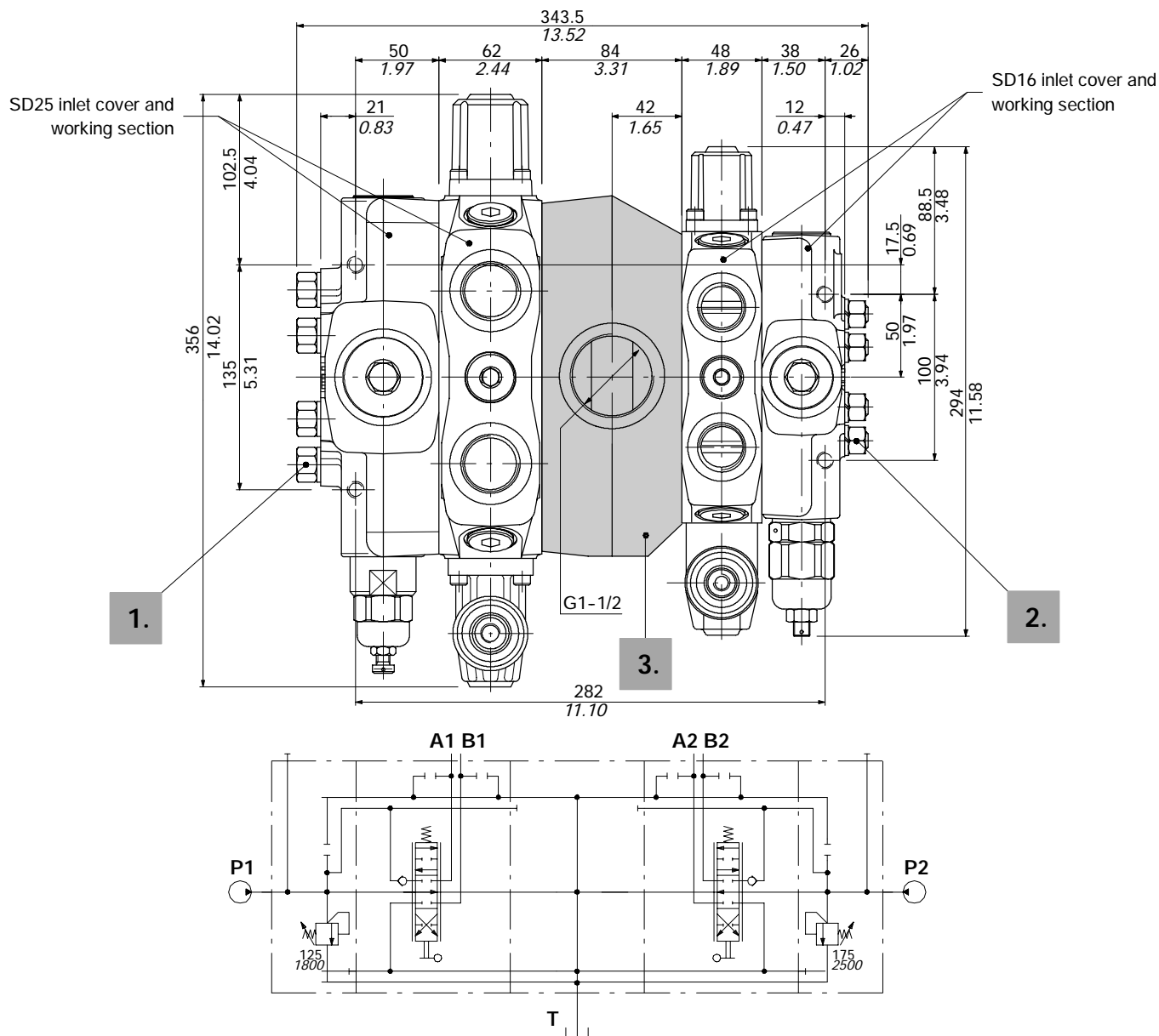

Description example: SD25/1/AC(XG-125)/18L/CS3/18L/BC(YG3-175)/SD16/1

1. Tie rod kits for SD25

CODE	DESCRIPTION
5TIR4251	Kit for 1 section
5TIR4252	Kit for 2 sections
5TIR4253	Kit for 3 sections
5TIR4254	Kit for 4 sections

2. Tie rod kits for SD16

CODE	DESCRIPTION
5TIR4161	Kit for 1 section
5TIR4162	Kit for 2 sections
5TIR4163	Kit for 3 sections
5TIR4164	Kit for 4 sections

3. Intermediate sections *

CODE	DESCRIPTION
617441010	Mid return manifold section

NOTE (*) - Code are referred to **BSP** thread.

Outlet cover options

Example:

FS SD25 / RC *

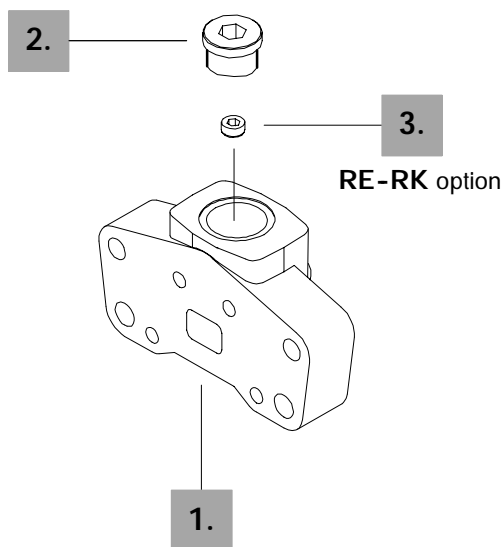

Outlet section parts

PART	CODE	QTY	DESCRIPTION
1.	3FIA225300	1	Outlet section body *
2.	3XTAP750240	1	G 1-1/4 plug *

Circuit option

PART	CODE	QTY	DESCRIPTION
3.	4TAP426612	1	G 3/4 plug for carry-over (RE) and closed centre (RK) configuration

NOTE (*) - Items are referred to *BSP* thread.

The SD25 valve is assembled and tested as per the technical specification of this catalogue.

Before the final installation on your equipment, follow the below recommendations:

- the valve can be assembled in any position, in order to prevent working sections deformation and spools sticking mount the product on a flat surface;
- in order to prevent the possibility of water entering the lever box and spool control kit, do not use high pressure wash down directly on the valve;
- prior to painting, ensure plastic port plugs are tightly in place.

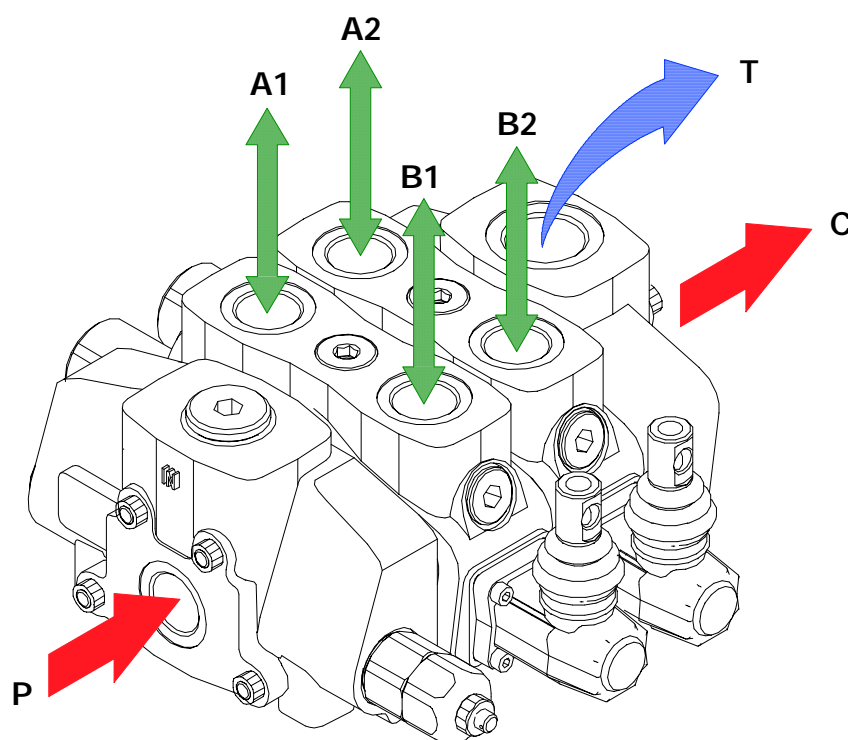

Carry-over configuration

Fitting tightening torque - Nm / lbft

THREAD TYPE	P and C ports	A and B ports	T port
BSP (ISO 228/1)	G 1	G 1	G 1-1/4
With O-Ring seal	100 / 73.7	100 / 73.7	190 / 140.2
With copper washer	90 / 66.3	90 / 66.3	150 / 110.6
With steel and rubber washer	100 / 73.7	100 / 73.7	190 / 140.2
UN-UNF (ISO 11926-1)	1 5/8-12 UN-2B (SAE 20)	1 5/16-12 UN-2B (SAE 16)	1 5/8-12 UN-2B (SAE 20)
With O-Ring seal	200 / 147.5	150 / 110.6	200 / 147.5

NOTE - These torque are recommended. Assembly tightening torque depends on many factors, including lubrication, coating and surface finish. The manufacturer shall be consulted.

Notes

The SD25 valve can be supplied with one coat of opaque black paint (CVN configuration).

Example of specification: SD25/2/AC(XG-125)/18L/18L/RC-<CVN>

NOTE - *For different color consult Sales Dept.*



WALVOIL S.P.A.

42100 REGGIO EMILIA • ITALY • VIA ADIGE, 13/D
TEL. +39.0522.932411 • FAX +39.0522.300984
E-MAIL: INFO@WALVOIL.COM • HTTP: //WWW.WALVOIL.COM

SALES DEPARTMENT

TEL. +39.0522.932555 • FAX +39.0522.932455

DBC005E