

APPLICATION

Plates type 3UL10/5 with thread connections are used to mount cartridge valves **nominal size 10 (NS10)** produced by **PONAR - WADOWICE S.A.**

DESCRIPTION OF OPERATION

Plate type 3UL10/5 allows to mount into thread connections cartridge valves (pressure valve, directional control valve) **nominal size 10 (NS10)** by

means of the connection (2) of the element in the housing (1) and connections of pipelines (3).

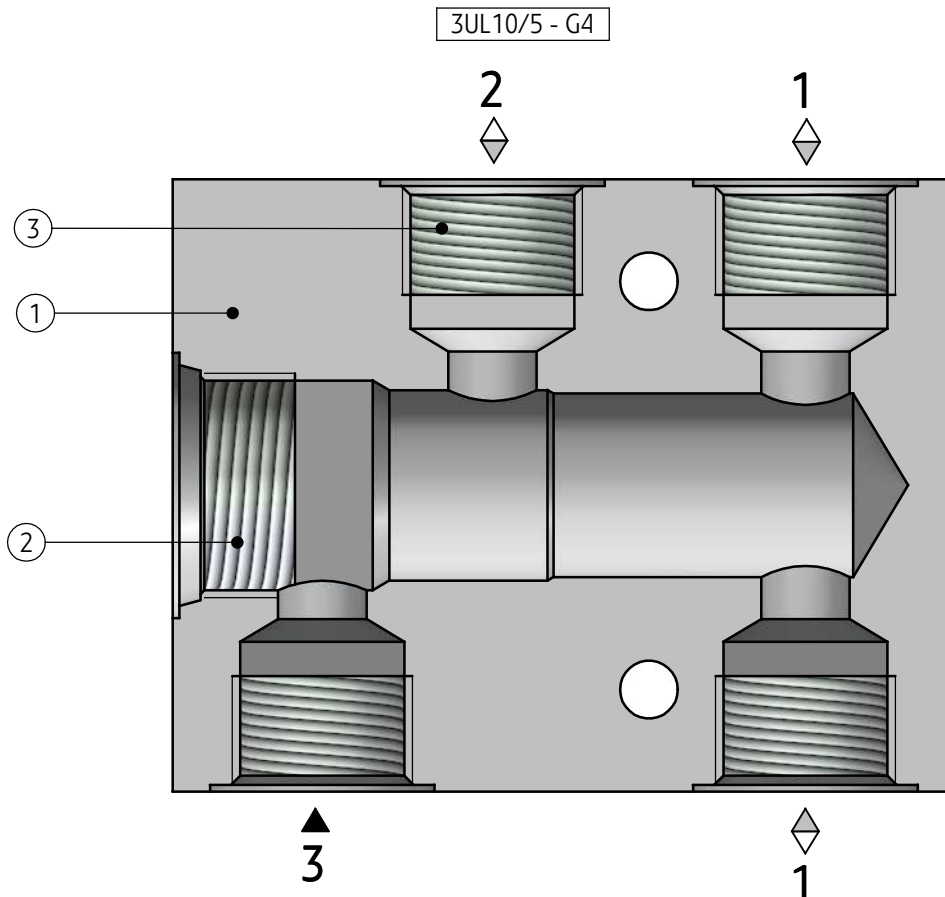

OVERALL AND CONNECTION DIMENSIONS

Plate type 3UL10/4 - G4

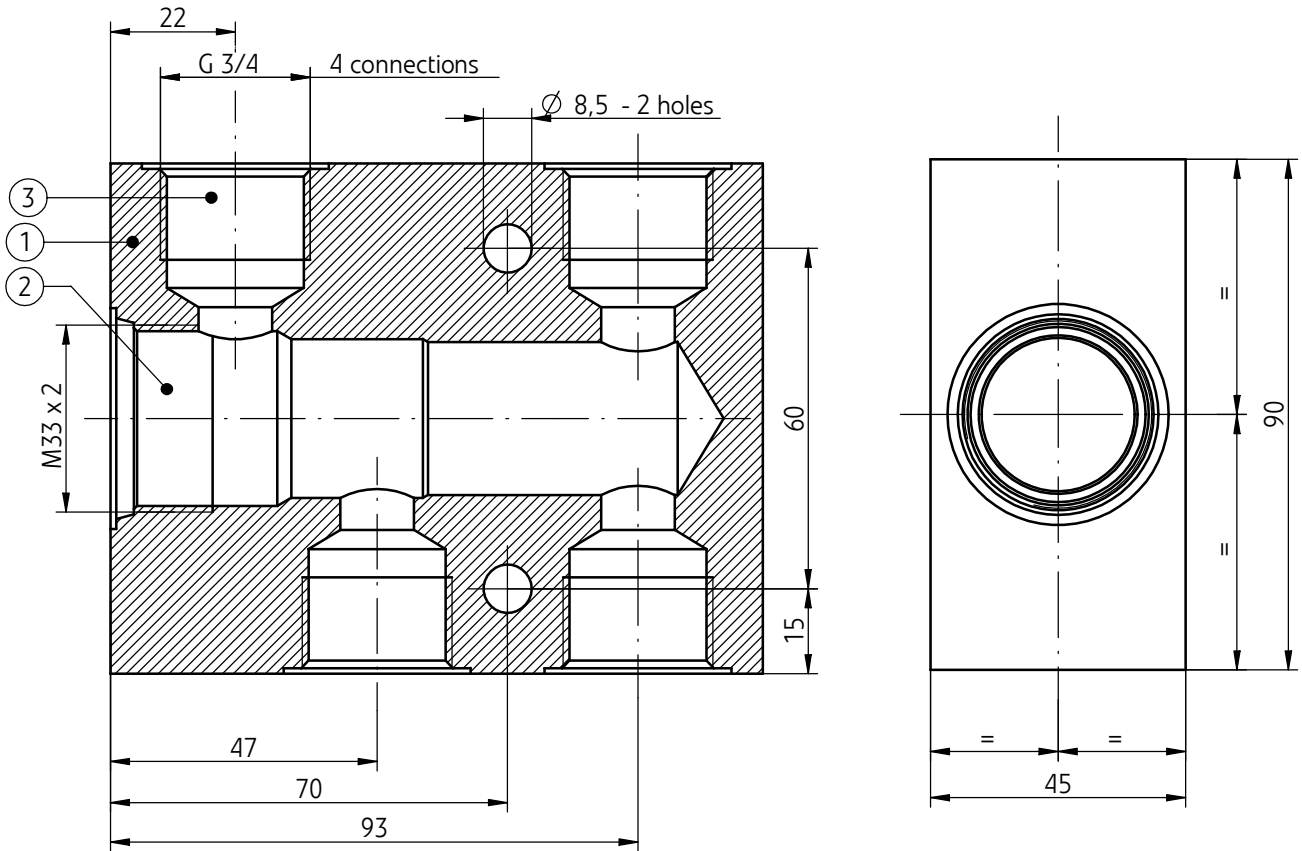

- 1 - Housing
- 2 - Connection of the element nominal size 10 (NS10)
(directional control valve or pressure valve)
- 3 - Connection of pipelines G 3/4 (G4)

OVERALL AND CONNECTION DIMENSIONS

Connection of the element nominal size 10 (NS10)

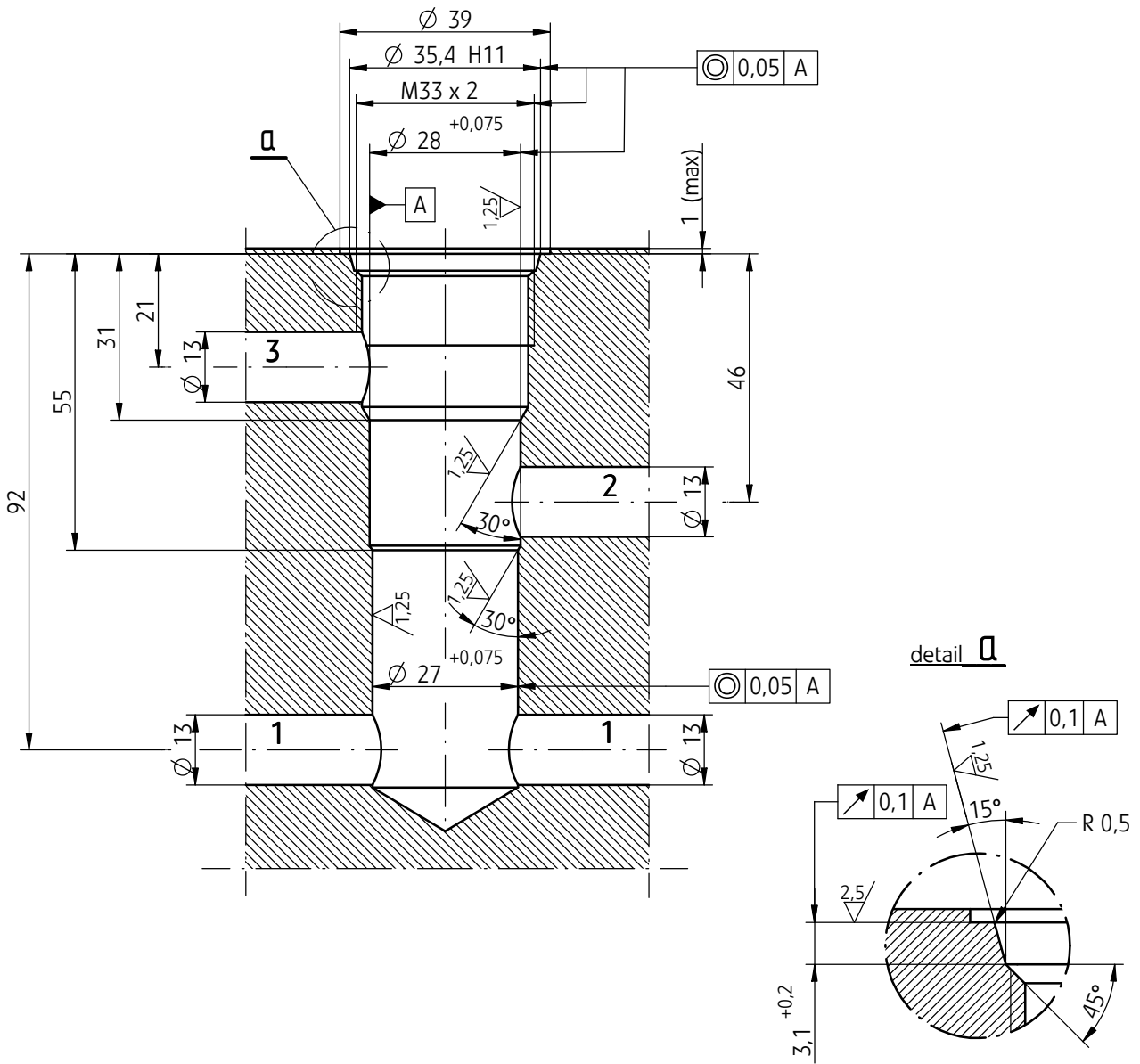

Connection of pipelines G3/4 (G4)

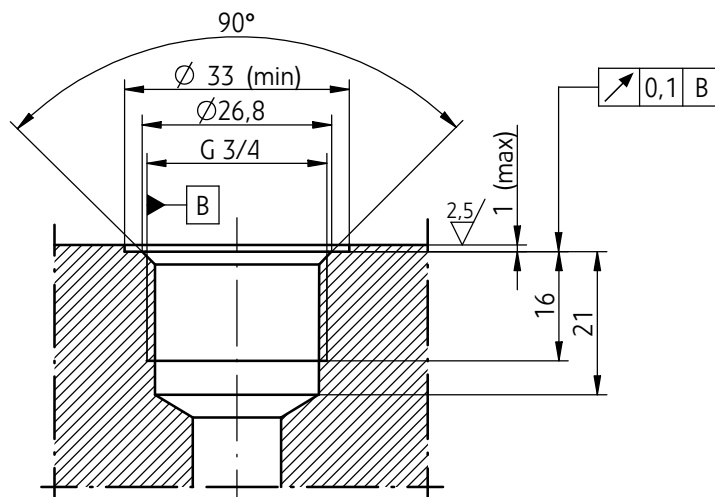

HOW TO ORDER

	3	UL	10 /	5	- G4	★
Type of connection for hydraulic element (valve or directional control valve NS 10) 3-way connection						
	= 3					
Nominal size of plate NS10						
	= 10					
Configuration of thread connections of pipelines Positioning of connections according to the drawing – see page 2						
	= 5					
Type of connections of pipelines Connection G3/4						
	= G4					
Further requirements in clear text (to be agreed with the manufacturer)						

NOTES:

The plate should be ordered according to the above coding.

The symbols in bold are preferred versions in short delivery time.

Coding example: 3UL10/5 – G4

PONAR Wadowice S.A.
ul. Wojska Polskiego 29
34-100 Wadowice
tel. +48 33 488 29 00
fax.+48 33 488 21 03
www.ponar-wadowice.pl

